

# Physics C Science League Test Orchid

January 14, 2016

No corrections

**DIRECTIONS:** Please PRINT your name, school, area, and which test you are taking on the Scantron. For each statement or question, completely fill in the appropriate space on the answer sheet. Use the letter preceding the word or phrase or sketch which best completes the statement or answers the question. Unless stated otherwise assume ideal conditions including no friction with the air. Sketches are not to scale.

1. An object, which has a mass of 20.0 kg, is moving toward the right with a velocity of 10.0 m/s. As the object passes the origin, a force which varies with position begins to act on the object as shown in the graph at the right. What will be the velocity of this object as it passes the 50.0 meter point?
- A. 13.4 m/s    B. 10.0 m/s    C. 8.25 m/s  
D. 18.2 m/s    E. 32.0 m/s

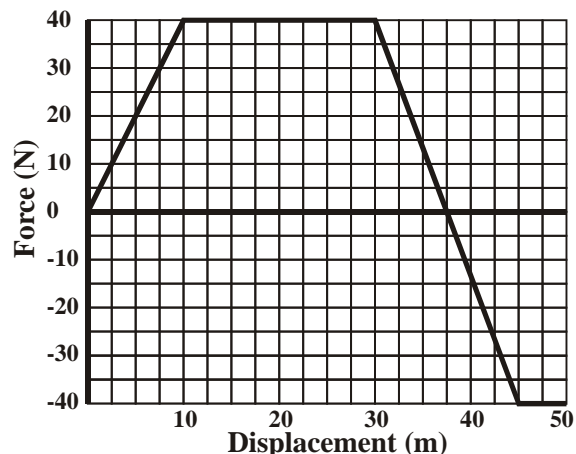

A 12 kg mass is confined to moving along the x-axis where the potential energy function is given by (Questions 2-3):

$$U(x) = -4x^3 + 300x + 500$$

2. Where along the x-axis can this 12 kg mass be placed so that it will remain at equilibrium?
- A. 1.0 m    B. 1.5 m    C. 2.0 m    D. 3.0 m    E. 5.0 m

This same 12 kg mass is then placed at  $x = 4.0$  m and is released.

3. What will be the speed of this mass when it reaches  $x = 2.0$  m?
- A. 3.8 m/s    B. 4.4 m/s    C. 5.3 m/s    D. 7.9 m/s    E. 8.4 m/s
4. A force given by  $F = (12i - 3j)$  N is applied to an object such that the final displacement of the object is  $d = (8i + 2j)$  m. How much work was done by this force?
- A. 24 J    B. 38 J    C. 90 J    D. 142 J    E. 218 J

A bullet, which has a mass of 100 grams, is fired straight up with a velocity of 350 m/s into a block of wood which has a mass of 2.0 kg and is at rest. The bullet lodges in the block (Questions 5-6).

5. What will be the velocity of the block immediately after the bullet lodges in the block?
- A. 16.7 m/s    B. 32.2 m/s    C. 36.4 m/s    D. 6.6 m/s    E. 12.4 m/s
6. What will be the maximum height H reached by the block above the point of impact?
- A. 4.3 m    B. 5.2 m    C. 6.4 m    D. 14.2 m    E. 18.3 m

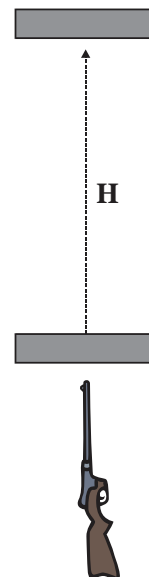

An object, which has a mass of 0.50 kg., is moving in a circle in such a way that the x- and y-coordinates of its motion, given in meters as functions of time  $t$  in seconds, are (Questions 7-8):

$$x = 8.0 \cdot \cos(4.0t) \quad y = 8.0 \cdot \sin(4.0t)$$

7. What is the radius of the resulting circular motion?  
 A. 2.0 m    B. 8.0 m    C. 32.0 m    D. 64.0 m    E. 128.0 m
8. What is the magnitude of the centripetal force acting on this particle?  
 A. 2.0 N    B. 8.0 N    C. 32.0 N    D. 64.0 N    E. 128.0 N

A horizontal force  $F_A$  is applied to a mass  $m$  on an inclined plane which has a coefficient of kinetic friction  $\mu_k$  and meets the horizontal at an angle  $\alpha$  as shown to the right. As a result of this force, the mass slides up the inclined plane at a constant speed (Questions 9-10).

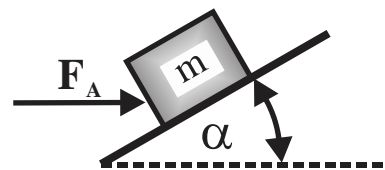

[ $F_A$  – applied force,  $F_N$  – normal force,  $F_f$  = friction force,  $F_g$  – gravitational force,  $F_p$  – parallel force]

9. Which of the following force diagrams correctly shows the forces acting on the mass as it slides up the incline?

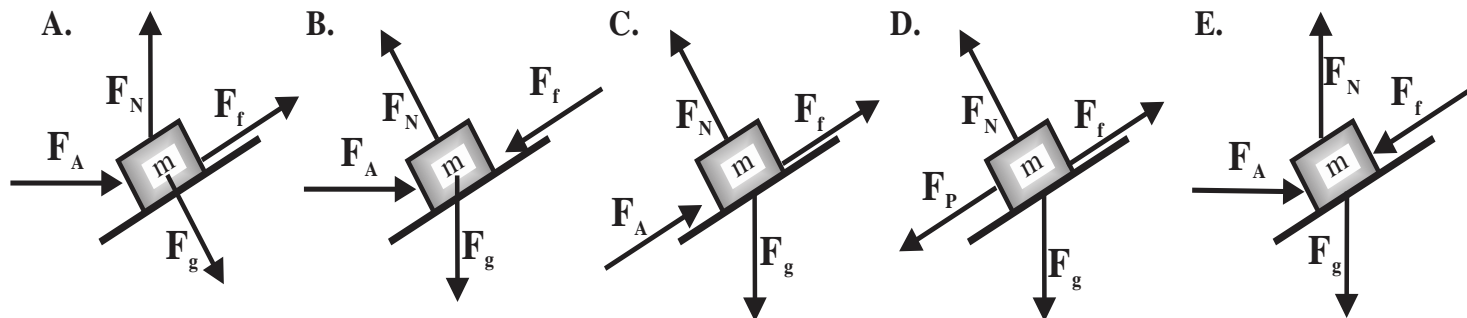

10. Which of the following expressions correctly describes the normal force acting on this mass as it slides up the incline at a constant speed?

A.  $F_N = m \cdot g$     B.  $F_N = m \cdot g \cdot \sin(\alpha)$     C.  $F_N = m \cdot g \cdot \cos(\alpha) + F_A \cdot \sin(\alpha)$   
 D.  $F_N = m \cdot g \cdot \cos(\alpha)$     E.  $F_N = m \cdot g \cdot \sin(\alpha) - F_A \cdot \cos(\alpha)$

A mass of  $m_1 = 8.0$  kg is moving towards the right with a velocity  $v_1 = 4.0$  m/s when it collides with a second mass of  $m_2 = 12.0$  kg moving towards the left at 2.0 m/s. After the collision, the mass  $m_1$  bounces off to the **left** of the original path of motion of  $m_1$  with a new velocity  $v_3 = 3.5$  m/s at an angle of  $\alpha = 42^\circ$ . The second mass  $m_2$  bounces off to the left of its original path of motion at an angle of  $\beta = 55.7^\circ$  as shown in the diagram. (Questions 11-12)

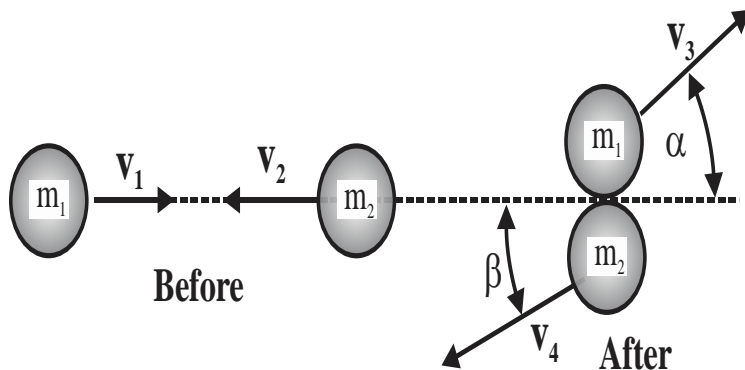

11. What will be the total momentum of this system immediately after the collision?  
 A. 56 kg·m/s    B. 18 kg·m/s    C. 12 kg·m/s    D. -18 kg·m/s    E. 8.0 kg·m/s
12. What will be the final speed  $v_4$  of mass  $m_2$  immediately after the collision?  
 A. 4.3 m/s    B. 1.9 m/s    C. 7.1 m/s    D. 6.4 m/s    E. 5.9 m/s

13. A crate with a mass  $m$  sits on a horizontal board which has a length  $L$ . A force  $F_A$  is applied upward as shown **slowly** lifting the right end of the incline at a constant speed until the mass suddenly begins to slide just as the right end of the board reaches a height  $h$ . What is the coefficient of static  $\mu_s$  friction between the crate and the board?

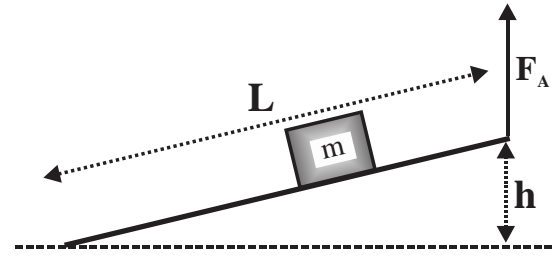

- A.  $\mu_s = h/L$       B.  $\mu_s = \frac{h}{\sqrt{L^2 - h^2}}$       C.  $\mu_s = \frac{L}{\sqrt{L^2 + h^2}}$   
 D.  $\mu_s = L/h$       E.  $\mu_s = \frac{\sqrt{L^2 - h^2}}{\sqrt{L^2 + h^2}}$

14. A baseball, which has a mass of  $m = 0.156$  kg., is moving with a speed of  $v_1 = 38.0$  m/s when it strikes the ground at an angle of  $\theta = 35^\circ$  as shown and then rebounds at the same angle but with a reduced speed of  $v_2 = 26$  m/s. What will be the magnitude of the impulse delivered to the ball by the ground?

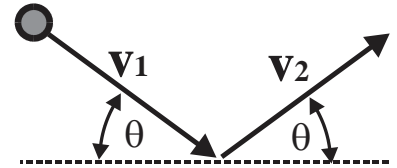

- A. 3.2 kg·m/s    B. 1.1 kg·m/s    C. 6.0 kg·m/s    D. 4.1 kg·m/s    E. 8.3 kg·m/s

**A ball A is thrown downward with a speed of 20.0 m/s from the top of a building 120 m high. At the exact same instant, a second ball B is thrown straight upward with a speed of 60.0m/s (Questions 15-17).**

15. How long after the balls are thrown will they collide?  
 A. 2.4 s    B. 1.5 s    C. 4.1 s    D. 3.2 s    E. 1.1 s
16. What will be the relative speed between these two balls at the moment they collide?  
 A. 24 m/s    B. 52 m/s    C. 80 m/s    D. 40 m/s    E. 50 m/s

**You are on top of a building  $h_1 = 225$  meters high when you kick a soccer ball with an initial velocity of  $v_0 = 34.0$  m/s at an angle of  $\alpha = 38.0^\circ$  above the horizontal. The soccer ball lands on the roof of a nearby building which is  $h_2 = 115$  meters tall as shown to the right.**

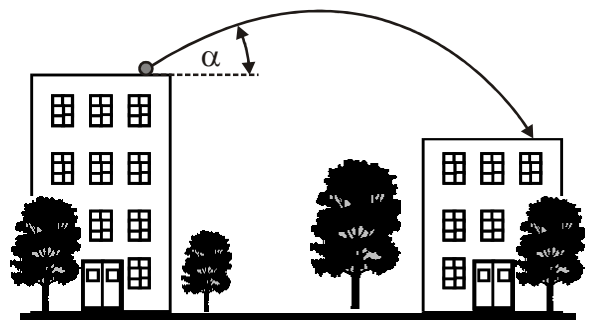

17. What is the maximum distance to the adjacent building?  
 A. 141 m    B. 196 m    C. 253 m    D. 384 m    E. 462 m

**A block with a mass  $m = 2.4$  kg is being pressed between a wood board and a wall as shown to the right by a force  $F_A = 36$  N. The coefficient of static friction between the wood board and block is  $\mu_s = 0.24$ .**

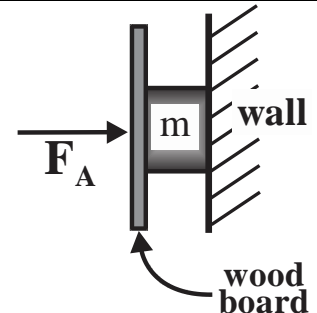

18. What is the minimum coefficient of static friction between the block and the wall if the block is to remain stationary?  
 A. 0.41    B. 0.24    C. 0.81    D. 0.68  
 E. the block will slide down the wall no matter what the coefficient of static friction

A small bat, as shown to the right, has a length of  $L = 45.0$  cm and a mass density that varies with distance from the left end of the bat according to the relationship  $\lambda = (0.196 + 2.51 x^2)$  kg/m (Questions 19-20).

19. What is the total mass of the bat?  
 A. 0.085 kg    B. 0.215 kg    C. 0.185 kg  
 D. 0.164 kg    E. 0.311 kg
20. Where is the center of mass of the bat?  
 A. 0.220 m    B. 0.250 m    C. 0.277 m  
 D. 0.305 m    E. 0.327 m



A car, which has a mass  $m$ , is moving down a level road with a speed  $v_0$  when the transmission is put into neutral and is allowed to gradually come to a halt under the influence of a resistive drag force that is proportional to the speed of the car  $F_d = -bv$  (Questions 21-23).

21. Which of the following differential equations could be used to determine the velocity of this car as a function of time?  
 A.  $\frac{m}{b} dt = \frac{1}{v} dv$     B.  $\frac{-m}{b} dt = \frac{1}{v} dv$     C.  $-m \cdot dt = \frac{1}{v} dv$     D.  $\frac{-b}{m} dt = \frac{1}{v} dv$     E.  $\frac{-b}{m} dt = v \cdot dv$
22. Which of the following graphs best shows the velocity of the car as a function of time?

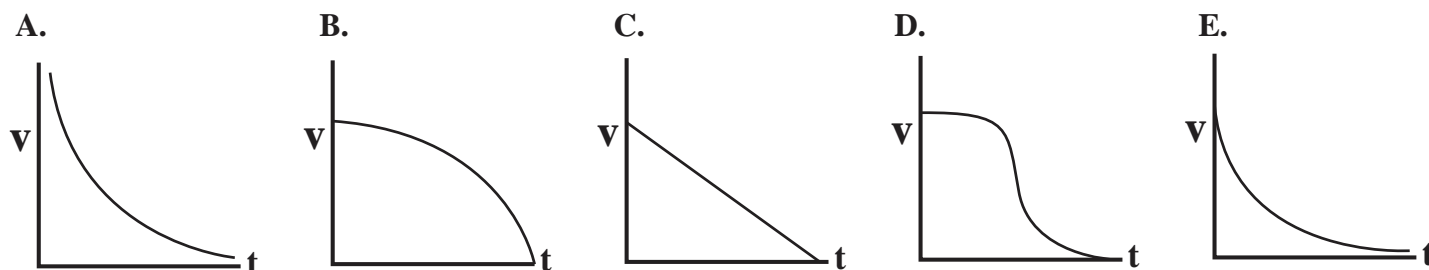

23. How far  $d$  will the car move from the time it is thrown into neutral until it essentially comes to rest?  
 A.  $d = v_0 b/m$     B.  $d = 2v_0 m \cdot b$     C.  $d = 3v_0 m/b$     D.  $d = 2v_0 m/b$     E.  $d = v_0 m/b$

The Daytona Speedway in Florida has a banked curve which has a radius of  $R = 330$  m and is banked at an angle of  $\alpha = 31^\circ$ . A race car is moving through the curve [out of the page in the diagram to the right] with a velocity  $v$ . On this particular day, it is raining and for all practical purposes there is no significant frictional force available to help the car get through the curve safely (Questions 24-25).

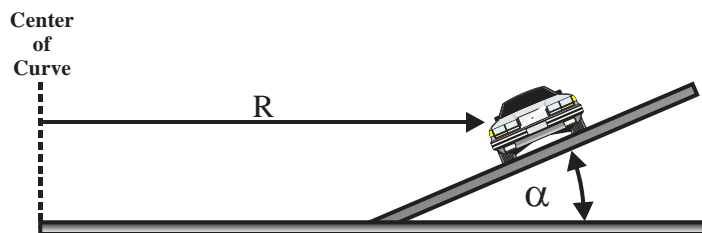

24. What force  $F_c$  is responsible for the centripetal acceleration of this race car?  
 A.  $F_c = F_g \sin(\alpha)$     B.  $F_c = F_N \sin(\alpha) + F_g \cos(\alpha)$     C.  $F_c = F_g \sin(\alpha) + F_N \cos(\alpha)$   
 D.  $F_c = F_N \cos(\alpha)$     E.  $F_c = F_N \sin(\alpha)$
25. What should the speed of this race car be in order for the car to negotiate the curve safely without any significant friction?  
 A. 18 m/s    B. 25 m/s    C. 28 m/s    D. 44 m/s    E. 51 m/s



# AP Physics C Formulae 1-12-2016

MECHANICS	ELECTRICITY AND MAGNETISM
$v = v_0 + at$ $x = x_0 + v_0t + \frac{1}{2}at^2$ $v^2 = v_0^2 + 2a(x - x_0)$ $\Sigma \mathbf{F} = \mathbf{F}_{net} = m\mathbf{a}$ $\mathbf{F} = \frac{d\mathbf{p}}{dt}$ $\mathbf{J} = \int \mathbf{F} dt = \Delta \mathbf{p}$ $\mathbf{p} = m\mathbf{v}$ $F_{fric} \leq \mu N$ $W = \int \mathbf{F} \cdot d\mathbf{r}$ $K = \frac{1}{2}mv^2$ $P = \frac{dW}{dt}$ $P = \mathbf{F} \cdot \mathbf{v}$ $\Delta U_g = mgh$ $a_c = \frac{v^2}{r} = \omega^2 r$ $\boldsymbol{\tau} = \mathbf{r} \times \mathbf{F}$ $\Sigma \boldsymbol{\tau} = \boldsymbol{\tau}_{net} = I\boldsymbol{\alpha}$ $I = \int r^2 dm = \Sigma mr^2$ $\mathbf{r}_{cm} = \Sigma m\mathbf{r} / \Sigma m$ $v = r\omega$ $\mathbf{L} = \mathbf{r} \times \mathbf{p} = I\boldsymbol{\omega}$ $K = \frac{1}{2}I\omega^2$ $\omega = \omega_0 + \alpha t$ $\theta = \theta_0 + \omega_0 t + \frac{1}{2}\alpha t^2$	$a = \text{acceleration}$ $F = \text{force}$ $f = \text{frequency}$ $h = \text{height}$ $I = \text{rotational inertia}$ $J = \text{impulse}$ $K = \text{kinetic energy}$ $k = \text{spring constant}$ $\ell = \text{length}$ $L = \text{angular momentum}$ $m = \text{mass}$ $N = \text{normal force}$ $P = \text{power}$ $p = \text{momentum}$ $r = \text{radius or distance}$ $\mathbf{r} = \text{position vector}$ $T = \text{period}$ $t = \text{time}$ $U = \text{potential energy}$ $v = \text{velocity or speed}$ $W = \text{work done on a system}$ $x = \text{position}$ $\mu = \text{coefficient of friction}$ $\theta = \text{angle}$ $\tau = \text{torque}$ $\omega = \text{angular speed}$ $\alpha = \text{angular acceleration}$ $\phi = \text{phase angle}$ $F_s = -kx$ $U_s = \frac{1}{2}kx^2$ $x = x_{max} \cos(\omega t + \phi)$ $T = \frac{2\pi}{\omega} = \frac{1}{f}$ $T_s = 2\pi\sqrt{\frac{m}{k}}$ $T_p = 2\pi\sqrt{\frac{\ell}{g}}$ $\mathbf{F}_G = -\frac{Gm_1m_2}{r^2}\hat{\mathbf{r}}$ $U_G = -\frac{Gm_1m_2}{r}$
$F = \frac{1}{4\pi\epsilon_0} \frac{q_1q_2}{r^2}$ $\mathbf{E} = \frac{\mathbf{F}}{q}$ $\oint \mathbf{E} \cdot d\mathbf{A} = \frac{Q}{\epsilon_0}$ $E = -\frac{dV}{dr}$ $V = \frac{1}{4\pi\epsilon_0} \sum_i \frac{q_i}{r_i}$ $U_E = qV = \frac{1}{4\pi\epsilon_0} \frac{q_1q_2}{r}$ $C = \frac{Q}{V}$ $C = \frac{\kappa\epsilon_0 A}{d}$ $C_p = \sum_i C_i$ $\frac{1}{C_s} = \sum_i \frac{1}{C_i}$ $I = \frac{dQ}{dt}$ $U_c = \frac{1}{2}QV = \frac{1}{2}CV^2$ $R = \frac{\rho\ell}{A}$ $E = \rho\mathbf{J}$ $I = Nevd_d A$ $V = IR$ $R_s = \sum_i R_i$ $\frac{1}{R_p} = \sum_i \frac{1}{R_i}$ $P = IV$ $\mathbf{F}_M = q\mathbf{v} \times \mathbf{B}$	$A = \text{area}$ $B = \text{magnetic field}$ $C = \text{capacitance}$ $d = \text{distance}$ $E = \text{electric field}$ $\mathcal{E} = \text{emf}$ $F = \text{force}$ $I = \text{current}$ $J = \text{current density}$ $L = \text{inductance}$ $\ell = \text{length}$ $n = \text{number of loops of wire per unit length}$ $N = \text{number of charge carriers per unit volume}$ $P = \text{power}$ $Q = \text{charge}$ $q = \text{point charge}$ $R = \text{resistance}$ $r = \text{distance}$ $t = \text{time}$ $U = \text{potential or stored energy}$ $V = \text{electric potential}$ $v = \text{velocity or speed}$ $\rho = \text{resistivity}$ $\phi_m = \text{magnetic flux}$ $\kappa = \text{dielectric constant}$ $\oint \mathbf{B} \cdot d\boldsymbol{\ell} = \mu_0 I$ $d\mathbf{B} = \frac{\mu_0}{4\pi} \frac{I d\boldsymbol{\ell} \times \mathbf{r}}{r^3}$ $\mathbf{F} = \int I d\boldsymbol{\ell} \times \mathbf{B}$ $B_s = \mu_0 nI$ $\phi_m = \int \mathbf{B} \cdot d\mathbf{A}$ $\mathcal{E} = \oint \mathbf{E} \cdot d\boldsymbol{\ell} = -\frac{d\phi_m}{dt}$ $\mathcal{E} = -L \frac{dI}{dt}$ $U_L = \frac{1}{2}LI^2$

# AP Physics C Formulae 1-12-2016

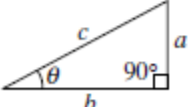
GEOMETRY AND TRIGONOMETRY	CALCULUS
<p>Rectangle</p> $A = bh$ <p>Triangle</p> $A = \frac{1}{2}bh$ <p>Circle</p> $A = \pi r^2$ $C = 2\pi r$ <p>Rectangular Solid</p> $V = \ell wh$ <p>Cylinder</p> $V = \pi r^2 \ell$ $S = 2\pi r \ell + 2\pi r^2$ <p>Sphere</p> $V = \frac{4}{3}\pi r^3$ $S = 4\pi r^2$ <p>Right Triangle</p> $a^2 + b^2 = c^2$ $\sin \theta = \frac{a}{c}$ $\cos \theta = \frac{b}{c}$ $\tan \theta = \frac{a}{b}$	$\frac{df}{dx} = \frac{df}{du} \frac{du}{dx}$ $\frac{d}{dx}(x^n) = nx^{n-1}$ $\frac{d}{dx}(e^x) = e^x$ $\frac{d}{dx}(\ln x) = \frac{1}{x}$ $\frac{d}{dx}(\sin x) = \cos x$ $\frac{d}{dx}(\cos x) = -\sin x$ $\int x^n dx = \frac{1}{n+1}x^{n+1}, n \neq -1$ $\int e^x dx = e^x$ $\int \frac{dx}{x} = \ln x $ $\int \cos x dx = \sin x$ $\int \sin x dx = -\cos x$
	

# Physics C Answer Key: Orchid Test Jan 14, 2016 (Corrections None)

1-A	6-D	11-E	16-C	21-D
2-E	7-B	12-B	17-B	22-E
3-D	8-D	13-B	18-A	23-E
4-C	9-B	14-C	19-D	24-E
5-A	10-C	15-B	20-C	25-D

### Topics:

**JANUARY:** kinematics in one and two dimensions; Newton's laws including resistance forces and dynamics of circular motion; vector algebra (mostly assumed as needed); energy and its conservation including potential energy and conservative forces, momentum and its conservation including two-dimensional situations

**FEBRUARY:** angular mechanics including rotational equilibrium, rotational dynamics, rotational energy, and angular momentum; oscillatory motion including kinematics, dynamics, energy, and damping; gravitation including kinematics and dynamics of planetary motion, angular momentum, and energy as applied to gravitation

**MARCH:** electrostatics including electrostatic forces, electrostatic field, electrostatic field flux and Gauss's Law; electrostatic potential and potential energy; dc electrical circuits including multi-loop circuits and power; capacitors, dielectrics, and circuits with capacitors

**APRIL:** Magnetic Fields and Forces including the applications of the Lorenz force, the Law of Biot-Savart, Ampere's Law, magnetic field flux and Faraday's Law, Lenz's Law for electromagnetic induction; magnetic materials, applications of electromagnetic induction, and circuits with inductors.

### Testing Dates for 2016

Thursday, January 14, 2016

Thursday, February 11, 2016

Thursday, March 10, 2016

Thursday, April 14, 2016\*

\*All areas and schools must complete the April exam and mail in the results by April 28<sup>th</sup>, 2016.

### New Jersey Science League

PO Box 65 Stewartsville, NJ 08886-0065

Phone #: 908-213-8923

Fax #: 908-213-9391

email: [newjsl@ptd.net](mailto:newjsl@ptd.net)

Web address: [entnet.com/~personal/njscil/html](http://entnet.com/~personal/njscil/html)

**PLEASE RETURN THE AREA RECORD SHEET AND ALL REGULAR TEAM MEMBER  
SCANTRONS (ALL STUDENTS PLACING 1<sup>ST</sup>, 2<sup>ND</sup>, 3<sup>RD</sup>, 4<sup>TH</sup>).**

If you return scantrons of the Alternates, then label them as ALTERNATES.

### Dates for 2017 Season

Thursday, January 12, 2017

Thursday, February 9, 2017

Thursday, March 9, 2017

Thursday, April 13, 2017



**Physics C Science League Test Orchid**  
**February 11, 2016 (Corrections)**

**DIRECTIONS:** Please PRINT your name, school, area, and which test you are taking on the Scantron supplied. For each statement or question, completely fill in the appropriate space on the answer sheet. Use the letter preceding the word or phrase or sketch which best completes the statement or answers the question. Unless stated otherwise assume ideal conditions including no friction. Sketches are not to scale. Assume  $g = -9.8\text{m/s}^2$  and the following moments of inertia:

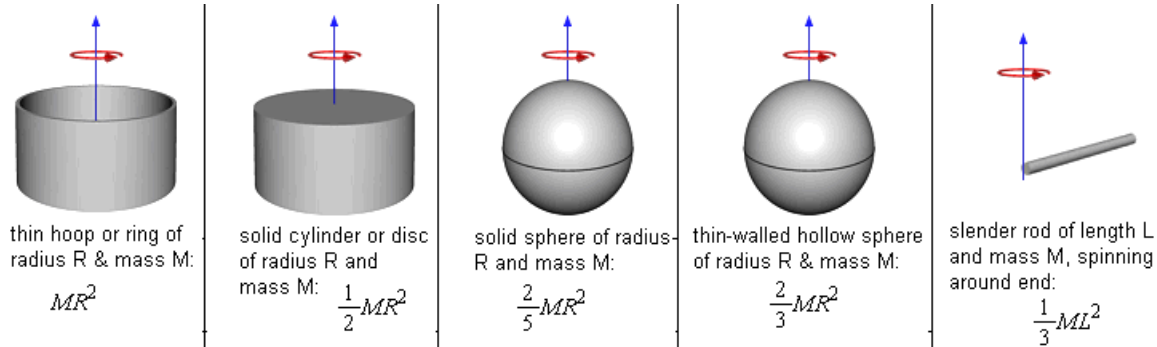

- The moment of inertia of a solid uniform sphere of a mass M and radius R is given by the equation  $I=(2/5)MR^2$ . Such a sphere is released from rest at the top of inclined plane of height h, length L, and incline angle  $\theta$ . If the sphere rolls without slipping, find its speed at the bottom of the incline.

A.  $\sqrt{\frac{10gh}{7}}$

D.  $\sqrt{\frac{2}{7}gL\sin\theta}$

B.  $\sqrt{\frac{5gh}{2}}$

E.  $\sqrt{\frac{7}{10}gL\sin\theta}$

C.  $\sqrt{\frac{7}{2}gh}$

- An object, originally at rest, begins spinning under uniform angular acceleration. In 10s, it completes an angular displacement of 60. rad. What is the numerical value of the angular acceleration?

A.  $0.3 \text{ rad/s}^2$

D.  $2.4 \text{ rad/s}^2$

B.  $0.6 \text{ rad/s}^2$

E.  $3.6 \text{ rad/s}^2$

C.  $1.2 \text{ rad/s}^2$

- An object spins with angular velocity  $\omega$ . If the object's moment of inertia increased by a factor of 2 without the application of an external torque, what will be the object's new angular velocity.

A.  $\omega/4$

D.  $\omega\sqrt{2}$

B.  $\omega/2$

E.  $2\omega$

C.  $\omega/\sqrt{2}$

4. A satellite is currently orbiting Earth in a circular orbit of radius  $R$ ; its kinetic energy is  $K$ . If the satellite is moved and enters a new circular orbit of radius  $2R$ , what will be its kinetic energy?
- A.  $K/4$                                       D.  $2K$   
 B.  $K/2$                                       E.  $4K$   
 C.  $K$

5. What is the rotational inertia of the following body about the indicated rotation axis? (The mass of connecting rods are negligible.)

- A.  $4mL^2$   
 B.  $\frac{32}{3}mL^2$   
 C.  $\frac{64}{9}mL^2$   
 D.  $\frac{128}{9}mL^2$   
 E.  $\frac{256}{9}mL^2$

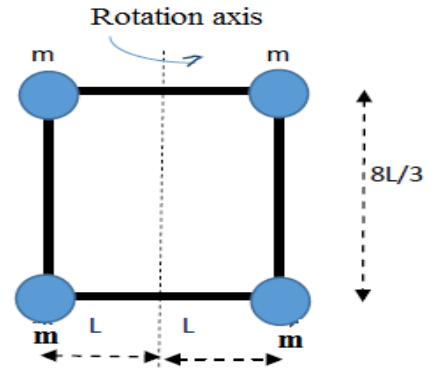

6. A planet orbits the Sun in an elliptical orbit of eccentricity  $e$ . What is the ratio of the planet's speed at perihelion to its speed at aphelion?

- A.  $\frac{1}{1-e}$                                       D.  $\frac{e}{1+e}$   
 B.  $\frac{e}{1-e}$   
 E.  $\frac{1+e}{1-e}$   
 C.  $\frac{1}{1+e}$

7. A block attached to an ideal spring undergoes simple harmonic motion about its equilibrium position with amplitude  $A$  and angular frequency  $\omega$ . What is the maximum magnitude of the block's velocity?

- A.  $A\omega$                                       D.  $A/\omega$   
 B.  $A^2/\omega$                                       E.  $A/\omega^2$   
 C.  $A\omega^2$

8. If a particle moves in a plane so that its position is described by the functions  $x = A \cos \omega t$  and  $y = A \sin \omega t$ , the particle is

- A. moving with constant speed along a circle  
 B. moving with varying speed along a circle  
 C. moving with constant acceleration along a straight line  
 D. moving along a parabola  
 E. oscillating back and forth along a straight line

9. The sum of all the external forces on a system of particles is zero. Which of the following must be true of the system?
- The total mechanical energy is constant.
  - The total potential energy is constant.
  - The total kinetic energy is constant.
  - The total linear momentum is constant.
  - It is in static equilibrium.

10. Let  $g$  be the acceleration due to gravity at the surface of a planet of radius  $R$ . Which of the following is a dimensionally correct formula for the minimum kinetic energy  $K$  that a projectile of mass  $m$  must have at the planet's surface if the projectile is to escape from the planet's gravitational field?

- |                    |                               |
|--------------------|-------------------------------|
| A. $K = \sqrt{gR}$ | D. $K = m \sqrt{\frac{g}{R}}$ |
| B. $K = mgR$       | E. $K = gR$                   |
| C. $K = mg/R$      |                               |

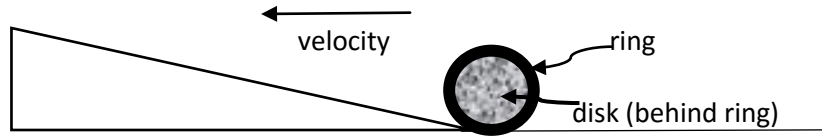

11. The ring and disk shown above have identical masses, radii, and velocities. They are not attached to each other. If the ring and the disk each roll without slipping up the inclined plane, how will the distances they move up the plane compare before coming to rest?

Assume that neither the ring or disk go over the end of the plane.

- The ring will move farther than will the disk.
- The disk will move farther than will the ring.
- The ring and the disk will move equal distances.
- The relative distances depend on the angle of elevation of the plane.
- The relative distances depend on the length of the plane.

12. A toy cannon is fixed to a small cart and both move to the right with speed  $v$  along a straight track, as shown below. The cannon points in the direction of motion. When the cannon fires a projectile the cart and cannon are brought to rest. If  $M$  is the mass of the cart and cannon combined without the projectile, and  $m$  is the mass of the projectile, what is the speed of the projectile relative to the ground immediately after it is fired?

- |                       |                       |
|-----------------------|-----------------------|
| A. $\frac{Mv}{m}$     | B. $\frac{(M+m)v}{m}$ |
| C. $\frac{(M-m)v}{m}$ | D. $\frac{mv}{M}$     |
| E. $\frac{mv}{m-M}$   |                       |

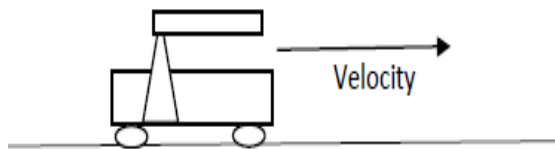

Use the following information for questions 13 and 14

The speed  $v$  of an automobile moving on a straight road is given in meters per second as a function of time  $t$  in seconds by the following equation:  $v = 4 + 2t^3$

13. What is the acceleration of the automobile at  $t = 2$  s?

- A.  $12 \text{ m/s}^2$
- B.  $16 \text{ m/s}^2$
- C.  $20 \text{ m/s}^2$
- D.  $24 \text{ m/s}^2$
- E.  $28 \text{ m/s}^2$

14. How far has the automobile traveled in the interval between  $t = 0$  and  $t = 2$  s?

- A. 16 m
- B. 20 m
- C. 24 m
- D. 32 m
- E. 72 m

15. A disk X rotates freely with angular velocity  $\omega$  on frictionless bearings, as shown below. A second identical disk Y, initially not rotating, is placed on X so that both disks rotate together without slipping. When the disks are rotating together, which of the following is **half** what it was before?

- A. Moment of inertia of X
- B. Moment of inertia of Y
- C. Angular velocity of X
- D. Angular velocity of Y
- E. Angular momentum of both disks

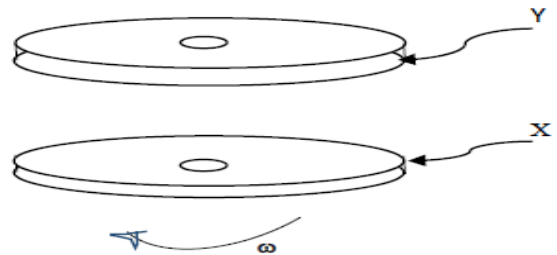

16. A disc with radius  $R$ , mass  $M$  and rotational inertia  $I$  rolls without slipping across the ground. If its translational kinetic energy is  $E$ , then what is its **rotational kinetic energy** about the center of mass? **All full credit.**

- A.  $E$
- B.  $E/2$
- C.  $E(I/MR^2)$
- D.  $E (MR^2/I)$
- E. **Cannot be determined from the information given.**

17. Two equal masses  $m_1=m_2=m$  are connected by a spring having Hook's constant  $k$ . If the equilibrium separation is  $l_0$  and the springs rests on a frictionless horizontal surface, then derive  $\omega_0$  the angular frequency. When the spring is stretched the masses are released. The system begins to oscillate.

- A.  $\sqrt{\frac{k}{m}}$
- B.  $\sqrt{\frac{2k}{m}}$
- C.  $\sqrt{3\frac{k}{m}}$
- D.  $2\sqrt{\frac{k}{m}}$
- E.  $\sqrt{\frac{g}{l}}$

18. Let the point of application of a  $F = (5,3,-2)\text{N}$  be at position  $r = (-2, 1, -3)\text{m}$ . Calculate the torque  $\tau$  about the origin due to this force:

- A.  $7x-19y-11z\text{N}-\text{m}$
- B.  $11x+11y+1z\text{N}-\text{m}$
- C.  $-10x+3y+6z\text{N}-\text{m}$
- D.  $-11x-11y-1z\text{N}-\text{m}$
- E.  $-7x+19y+11z\text{N}-\text{m}$

19. An object of mass 6kg oscillates harmonically with negligible damping with a frequency of 1.0Hz. With a small magnetic damping, the amplitude decreases from 0.25m to 0.125m after 10 seconds. Find the angular frequency for the damped system

- A. 6.28 rad/s
- B. 3.14 rad/s
- C. 1.07 rad/s
- D. 4.21 rad/s
- E. 5.28 rad/s

20. A 2400kg satellite is in a circular orbit around a planet. The satellite travels with a constant speed of 6670m/s. The radius of the circular orbit is  $8.92 \times 10^6\text{m}$ . Determine the magnitude of the gravitational force exerted on the satellite by the planet. **A is correct not E.**

- A.  $1.2 \times 10^4\text{N}$
- B.  $2.4 \times 10^4\text{N}$
- C.  $5 \times 10^{-3}\text{N}$
- D.  $7.5 \times 10^{-4}\text{N}$
- E. this cannot be determined since the mass and radius of the planet are not specified.

21. A small cylinder rests on a circular turntable that is rotating clockwise at a constant speed. The cylinder is at a distance of  $r = 12\text{cm}$  from the center of the turntable. The coefficient of static friction between the bottom of the cylinder and the surface of the turntable is 0.45. What is the maximum speed  $v_{\text{max}}$  that the cylinder can have without slipping off the turntable?

- A. 0.73m/s
- B. 0.53 m/s
- C. 7.3 m/s
- D. 0.25m/s

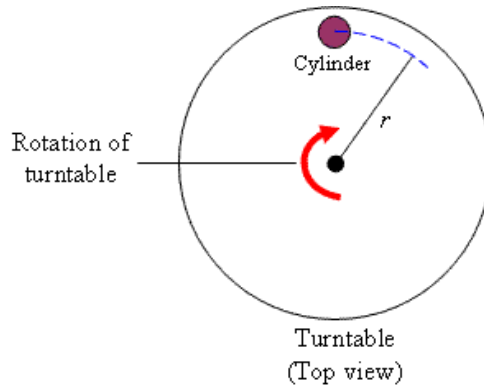

22. An object orbits a star in an elliptical orbit. The distance at aphelion is  $2a$  and the distance at perihelion is  $a$ . Determine the ratio of the object's speed at perihelion to that at aphelion.

- A. 2
- B. 3
- C. 1
- D.  $\sqrt{2}$
- E.  $\sqrt{3}$

23. Determine the gravitational field magnitude near the surface of a planet of radius  $R$  at altitude  $h$  to second order. Take  $g(h=0) = g_0$ .

A.  $g_0(1-2h/R)$

D.  $g_0(1+h/R+(h/R)^2)$

B.  $g_0(1-h/R+0.5(h/R)^2)$

E.  $g_0(1-2h/R+3(h/R)^2)$

C.  $g_0(1-h/R+(h/R)^2)$

24. One laboratory technique to determine the mass of one star of a binary star system involves measuring the distance  $a$  between the stars from parallax and observing the period of revolution  $T$ . Suppose  $m_1=m_2=m$ . what is mass  $m$ ?

A.  $\pi^2 a^3/GT^2$

B.  $2\pi^2 a^3/GT^2$

C.  $4\pi^2 a^3/GT^2$

D.  $8\pi^2 a^3/GT^2$

E.  $4\pi^2 a^3/GT^3$

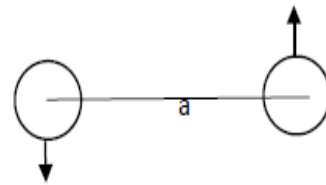

25. The space station in the drawing is rotating to create artificial gravity. The speed of the inner ring ( $r_i$ ) is one half that of the outer ring ( $r_o$ ). An astronaut walks from the inner to the outer ring. What happens to her apparent weight? That is how does her apparent weight at the outer ring compare to her apparent weight at the inner ring?

- A. Her apparent weight becomes four times as great
- B. Her apparent weight becomes half times as great
- C. Her apparent weight becomes one fourth times as great
- D. Her apparent weight does not change
- E. Her apparent weight becomes twice as great.

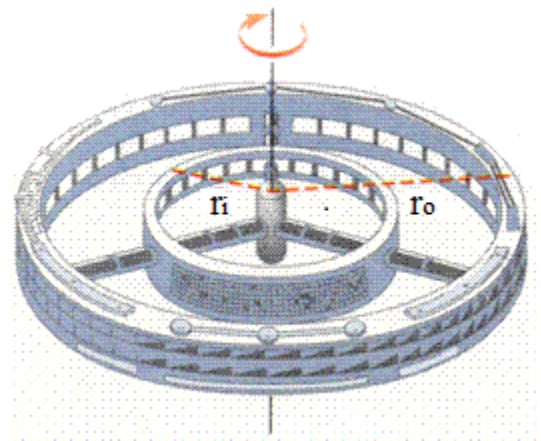

# AP Physics C Formulae 4-5-2016

## MECHANICS

$v = v_0 + at$ $x = x_0 + v_0t + \frac{1}{2}at^2$ $v^2 = v_0^2 + 2a(x - x_0)$ $\Sigma \mathbf{F} = \mathbf{F}_{net} = ma$ $\mathbf{F} = \frac{d\mathbf{p}}{dt}$ $\mathbf{J} = \int \mathbf{F} dt = \Delta \mathbf{p}$ $\mathbf{p} = m\mathbf{v}$ $F_{fric} \leq \mu N$ $W = \int \mathbf{F} \cdot d\mathbf{r}$ $K = \frac{1}{2}mv^2$ $P = \frac{dW}{dt}$ $P = \mathbf{F} \cdot \mathbf{v}$ $\Delta U_g = mgh$ $a_c = \frac{v^2}{r} = \omega^2 r$ $\boldsymbol{\tau} = \mathbf{r} \times \mathbf{F}$ $\Sigma \boldsymbol{\tau} = \boldsymbol{\tau}_{net} = I\boldsymbol{\alpha}$ $I = \int r^2 dm = \Sigma mr^2$ $\mathbf{r}_{cm} = \Sigma m\mathbf{r} / \Sigma m$ $v = r\omega$ $\mathbf{L} = \mathbf{r} \times \mathbf{p} = I\boldsymbol{\omega}$ $K = \frac{1}{2}I\omega^2$ $\omega = \omega_0 + \alpha t$ $\theta = \theta_0 + \omega_0 t + \frac{1}{2}\alpha t^2$	$a = \text{acceleration}$ $F = \text{force}$ $f = \text{frequency}$ $h = \text{height}$ $I = \text{rotational inertia}$ $J = \text{impulse}$ $K = \text{kinetic energy}$ $k = \text{spring constant}$ $\ell = \text{length}$ $L = \text{angular momentum}$ $m = \text{mass}$ $N = \text{normal force}$ $P = \text{power}$ $p = \text{momentum}$ $r = \text{radius or distance}$ $\mathbf{r} = \text{position vector}$ $T = \text{period}$ $t = \text{time}$ $U = \text{potential energy}$ $v = \text{velocity or speed}$ $W = \text{work done on a system}$ $x = \text{position}$ $\mu = \text{coefficient of friction}$ $\theta = \text{angle}$ $\tau = \text{torque}$ $\omega = \text{angular speed}$ $\alpha = \text{angular acceleration}$ $\phi = \text{phase angle}$ $\mathbf{F}_s = -k\mathbf{x}$ $U_s = \frac{1}{2}kx^2$ $x = x_{max} \cos(\omega t + \phi)$ $T = \frac{2\pi}{\omega} = \frac{1}{f}$ $T_s = 2\pi\sqrt{\frac{m}{k}}$ $T_p = 2\pi\sqrt{\frac{\ell}{g}}$ $\mathbf{F}_G = -\frac{Gm_1m_2}{r^2}\hat{\mathbf{r}}$ $U_G = -\frac{Gm_1m_2}{r}$
---	---

## ELECTRICITY AND MAGNETISM

$F = \frac{1}{4\pi\epsilon_0} \frac{q_1q_2}{r^2}$ $\mathbf{E} = \frac{\mathbf{F}}{q}$ $\oint \mathbf{E} \cdot d\mathbf{A} = \frac{Q}{\epsilon_0}$ $E = -\frac{dV}{dr}$ $V = \frac{1}{4\pi\epsilon_0} \sum_i \frac{q_i}{r_i}$ $U_E = qV = \frac{1}{4\pi\epsilon_0} \frac{q_1q_2}{r}$ $C = \frac{Q}{V}$ $C = \frac{\kappa\epsilon_0 A}{d}$ $C_p = \sum_i C_i$ $\frac{1}{C_s} = \sum_i \frac{1}{C_i}$ $I = \frac{dQ}{dt}$ $U_c = \frac{1}{2}QV = \frac{1}{2}CV^2$ $R = \frac{\rho\ell}{A}$ $\mathbf{E} = \rho\mathbf{J}$ $I = Nev_d A$ $V = IR$ $R_s = \sum_i R_i$ $\frac{1}{R_p} = \sum_i \frac{1}{R_i}$ $P = IV$ $\mathbf{F}_M = q\mathbf{v} \times \mathbf{B}$	$A = \text{area}$ $B = \text{magnetic field}$ $C = \text{capacitance}$ $d = \text{distance}$ $E = \text{electric field}$ $\mathcal{E} = \text{emf}$ $F = \text{force}$ $I = \text{current}$ $J = \text{current density}$ $L = \text{inductance}$ $\ell = \text{length}$ $n = \text{number of loops of wire per unit length}$ $N = \text{number of charge carriers per unit volume}$ $P = \text{power}$ $Q = \text{charge}$ $q = \text{point charge}$ $R = \text{resistance}$ $r = \text{distance}$ $t = \text{time}$ $U = \text{potential or stored energy}$ $V = \text{electric potential}$ $v = \text{velocity or speed}$ $\rho = \text{resistivity}$ $\phi_m = \text{magnetic flux}$ $\kappa = \text{dielectric constant}$ $\oint \mathbf{B} \cdot d\boldsymbol{\ell} = \mu_0 I$ $d\mathbf{B} = \frac{\mu_0 I d\boldsymbol{\ell} \times \mathbf{r}}{4\pi r^3}$ $\mathbf{F} = \int I d\boldsymbol{\ell} \times \mathbf{B}$ $B_s = \mu_0 nI$ $\phi_m = \int \mathbf{B} \cdot d\mathbf{A}$ $\mathcal{E} = \oint \mathbf{E} \cdot d\boldsymbol{\ell} = -\frac{d\phi_m}{dt}$ $\mathcal{E} = -L \frac{dI}{dt}$ $U_L = \frac{1}{2}LI^2$
--	--



# AP Physics C Formulae 4-5-2016

## GEOMETRY AND TRIGONOMETRY

Rectangle

$$A = bh$$

Triangle

$$A = \frac{1}{2}bh$$

Circle

$$A = \pi r^2$$

$$C = 2\pi r$$

$$s = r\theta$$

Rectangular Solid

$$V = \ell wh$$

Cylinder

$$V = \pi r^2 \ell$$

$$S = 2\pi r \ell + 2\pi r^2$$

Sphere

$$V = \frac{4}{3}\pi r^3$$

$$S = 4\pi r^2$$

Right Triangle

$$a^2 + b^2 = c^2$$

$$\sin \theta = \frac{a}{c}$$

$$\cos \theta = \frac{b}{c}$$

$$\tan \theta = \frac{a}{b}$$

$A$  = area

$C$  = circumference

$V$  = volume

$S$  = surface area

$b$  = base

$h$  = height

$\ell$  = length

$w$  = width

$r$  = radius

$s$  = arc length

$\theta$  = angle

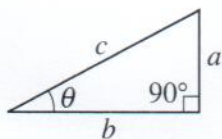
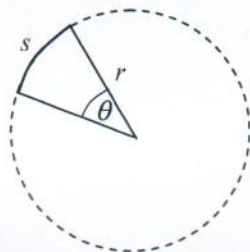

## CALCULUS

$$\frac{df}{dx} = \frac{df}{du} \frac{du}{dx}$$

$$\frac{d}{dx}(x^n) = nx^{n-1}$$

$$\frac{d}{dx}(e^{ax}) = ae^{ax}$$

$$\frac{d}{dx}(\ln ax) = \frac{1}{x}$$

$$\frac{d}{dx}[\sin(ax)] = a \cos(ax)$$

$$\frac{d}{dx}[\cos(ax)] = -a \sin(ax)$$

$$\int x^n dx = \frac{1}{n+1} x^{n+1}, n \neq -1$$

$$\int e^{ax} dx = \frac{1}{a} e^{ax}$$

$$\int \frac{dx}{x+a} = \ln|x+a|$$

$$\int \cos(ax) dx = \frac{1}{a} \sin(ax)$$

$$\int \sin(ax) dx = -\frac{1}{a} \cos(ax)$$

## VECTOR PRODUCTS

$$\vec{A} \cdot \vec{B} = AB \cos \theta$$

$$|\vec{A} \times \vec{B}| = AB \sin \theta$$



# Physics C Answer Key: Orchid Test

February 11, 2016

Record onto the area record the % correct

(Corrections)

1. A	6. E	11. A	16. C (All full credit)	21. A
2. C	7. A	12. B	17. B	22. A
3. B	8. A	13. D	18. A	23. E
4. B	9. D	14. A	19. A	24. B
5. A	10. B	15. C	20. A not E	25. E

**JANUARY:** kinematics in one and two dimensions; Newton's laws including resistance forces and dynamics of circular motion; vector algebra (mostly assumed as needed); energy and its conservation including potential energy and conservative forces, momentum and its conservation including two-dimensional situations

**FEBRUARY:** angular mechanics including rotational equilibrium, rotational dynamics, rotational energy, and angular momentum; oscillatory motion including kinematics, dynamics, energy, and damping; gravitation including kinematics and dynamics of planetary motion, angular momentum, and energy as applied to gravitation

**MARCH:** electrostatics including electrostatic forces, electrostatic field, electrostatic field flux and Gauss's Law; electrostatic potential and potential energy; dc electrical circuits including multi-loop circuits and power; capacitors, dielectrics, and circuits with capacitors

**APRIL:** Magnetic Fields and Forces including the applications of the Lorenz force, the Law of Biot-Savart, Ampere's Law, magnetic field flux and Faraday's Law, Lenz's Law for electromagnetic induction; magnetic materials, applications of electromagnetic induction, and circuits with inductors.

## Testing Dates for 2016

Thursday, February 11, 2016

Thursday, March 10, 2016

Thursday, April 14, 2016\*

\*All areas and schools must complete the April exam and mail in the results by April 28<sup>th</sup>, 2016.

## **New Jersey Science League**

**PO Box 65 Stewartsville, NJ 08886-0065**

**Phone #:** 908-213-8923 **Fax #:** 908-213-9391 **email:** [newjsl@ptd.net](mailto:newjsl@ptd.net)

**Web address:** [entnet.com/~personal/njscil/html](http://entnet.com/~personal/njscil/html)

**PLEASE RETURN THE AREA RECORD SHEET AND ALL REGULAR TEAM MEMBER  
SCANTRONS (ALL STUDENTS PLACING 1<sup>ST</sup>, 2<sup>ND</sup>, 3<sup>RD</sup>, 4<sup>TH</sup>).**

If you return scantrons of the Alternates, then label them as ALTERNATES.

**Dates for 2017 Season**

Thursday, January 12, 2017

Thursday, February 9, 2017

Thursday, March 9, 2017

Thursday, April 13, 2017

# Physics C Science League Test

March 10, 2016

## Orchid Color Exam (Corrections)

**DIRECTIONS:** Please PRINT your name, school, area, and which test you are taking on the Scantron. For each statement or question, completely fill in the appropriate space on the answer sheet. Use the letter preceding the word or phrase or sketch which best completes the statement or answers the question. Unless stated, otherwise assume ideal conditions including no friction with the air. Sketches are not to scale.

Two equal positive charges of  $8.0 \mu\text{C}$  are fixed on the x-axis, one at  $A = (-0.15 \text{ m}, 0.0 \text{ m})$  and the other at  $B = (+0.15 \text{ m}, 0.0 \text{ m})$ , as shown on the right. Point P is a point on the y-axis with coordinates  $P = (0, 0.12 \text{ m})$ .

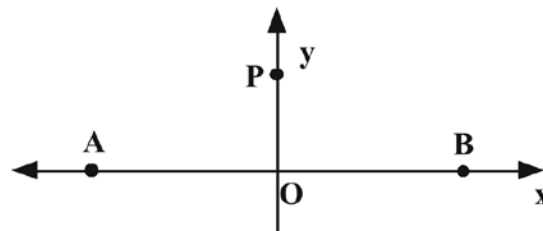

1. What will be the electric field strength at the origin, O? All full credit. Constant not given.  
A.  $3.2 \times 10^6 \text{ N/C}$       B.  $6.4 \times 10^6 \text{ N/C}$   
C.  $9.6 \times 10^6 \text{ N/C}$       D.  $1.6 \times 10^6 \text{ N/C}$       E. zero N/C
2. What will be the electric potential at the origin?  
A.  $3.2 \times 10^5 \text{ V}$       B.  $6.4 \times 10^5 \text{ V}$       C.  $9.6 \times 10^5 \text{ V}$       D.  $1.6 \times 10^5 \text{ V}$       E.  $0.0 \text{ V}$
3. What will be the direction of the electric field at point P?  
A. towards the left      B. towards the right      C. towards the bottom of the page  
D. towards the top of the page      E. into the page
4. What will be the magnitude of the electric field at point P?  
A.  $1.2 \times 10^6 \text{ N/C}$       B.  $4.3 \times 10^6 \text{ N/C}$       C.  $9.3 \times 10^6 \text{ N/C}$       D.  $2.4 \times 10^6 \text{ N/C}$       E.  $3.6 \times 10^6 \text{ N/C}$
5. How much work would be required to move an alpha particle,  $q = 3.2 \times 10^{-19} \text{ C}$ , from point P to the origin?  
A.  $6.7 \times 10^{-14} \text{ J}$       B.  $3.5 \times 10^{-13} \text{ J}$       C.  $1.7 \times 10^{-14} \text{ J}$       D.  $1.9 \times 10^{-13} \text{ J}$       E.  $6.2 \times 10^{-13} \text{ J}$

A small conducting sphere A, which has a radius  $r$  and contains a charge  $4q$ , is initially separated by a distance  $d$  from a second small conducting sphere B, which has a radius  $2r$  and contains a charge  $-q$ . The magnitude of the resulting force between these two spheres is  $F$ . These two spheres are then briefly brought together, touched, and are then moved apart to the same separation distance  $d$ .

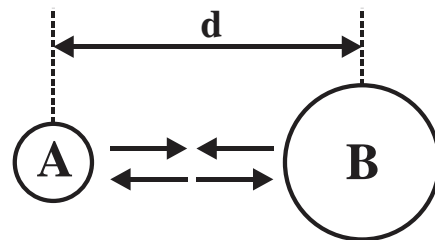

6. What will be the residual charge on each of these two balls (A,B) after they have been separated back to the original distance  $d$ ?
- A.  $(3q,q)$       B.  $(q,2q)$       C.  $(\frac{3}{2}q, \frac{3}{2}q)$       D.  $(2q,2q)$       E.  $(3q,2q)$
7. What will be the magnitude of the new force between these two spheres after they have separated back to the original distance  $d$ ?
- A.  $\frac{1}{2} F$       B.  $\frac{1}{3} F$       C.  $\frac{9}{4} F$       D.  $2 F$       E.  $\frac{9}{16} F$

**A rubber rod is rubbed with fur.**

8. The rubber rod will \_\_\_\_\_.
- A. become positively charged as the fur removes electrons from the rod  
 B. lose protons to the fur becoming negatively charged  
 C. become negatively charged by gaining electrons from the fur  
 D. lose protons to the fur and become positively charged  
 E. gain protons from the fur becoming positively charged

This charged rubber rod is then brought close to, but is not touching, an empty aluminum soda can sitting on a level tabletop. As a result . . .



9. the soda can will \_\_\_\_\_.
- gain a negative charge from the rubber rod and will be repelled by the rod
  - gain a positive charge from the rubber rod and will be attracted to the rod
  - develop an induced charge distribution causing the can to be attracted to the rubber rod
  - be unaffected by the rod since the can is neutral
  - develop an induced charge distribution causing the can to be repelled by the rubber rod

Consider each of the following capacitors with designs as shown below.

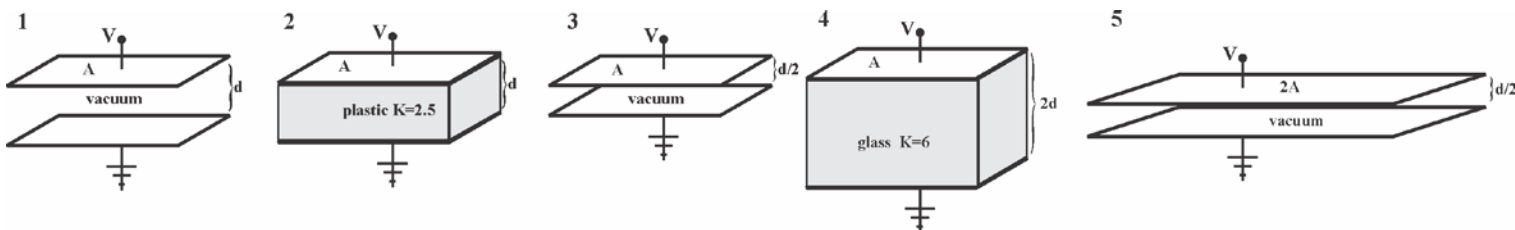

10. Which of the following lists ranks these capacitors in order from most to least capacitance?
- 4,3,5,1,2
  - 3,5,4,1,2
  - 2,1,5,3,4
  - 5,4,2,3,1
  - 3,5,2,4,1

The circuit elements in the circuit to the right have values:  $V_1 = 48\text{V}$ ,  $V_2 = 12\text{V}$ ,  $R_1 = 10\ \Omega$  and  $R_2 = 40\ \Omega$ . The currents in the two loops of the circuit are as shown.

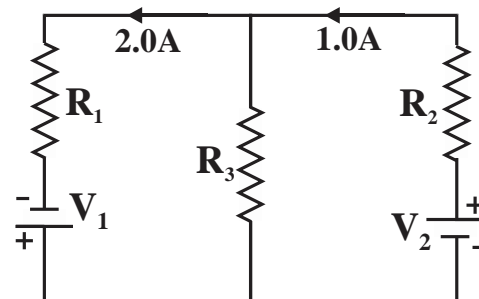

11. What is the value of the resistance  $R_3$ ?
- $14\ \Omega$
  - $22\ \Omega$
  - $24\ \Omega$
  - $28\ \Omega$
  - $36\ \Omega$
12. How much energy will be dissipated in resistor  $R_1$  over a period of 20 minutes?
- 400 J
  - 800 J
  - 1600 J
  - 48000 J
  - 120,000 J

Each of the capacitors in the following circuit have the same capacitance  $C$ .

13. What is the equivalent capacitance of this network?
- $6C$
  - $\frac{8}{3}C$
  - $\frac{11}{8}C$
  - $\frac{8}{5}C$
  - $\frac{8}{13}C$

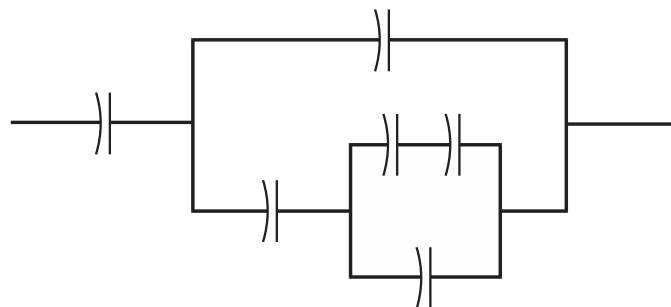

Two parallel plates are arranged as shown below with points X, Y and Z located between the plates.

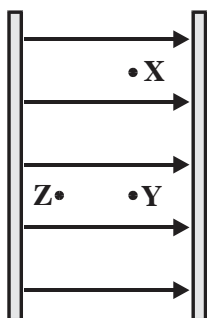

14. Which of the following statements about these three points is/are correct?
- The left plate is negative and the right plate is positive.
  - A positive charge placed at Z feels more force than it would at point Y.
  - Points X and Y are at the same potential.
  - The electric potential at Z is greater than the potential X.
- 1,2
  - 1,3
  - 1,2,3,4
  - 3,4
  - 2,3

A capacitor consists two parallel plates, each with an area  $A$ , placed a distance  $d$  apart and separated by mica, which has a dielectric constant of  $K = 8$ . This capacitor is then attached to a battery with an EMF  $\mathcal{E}$  until it is fully charged. This capacitor is then removed from the battery. At this point, the capacitor is storing  $U_0$  energy. Very quickly the mica is removed from between the two capacitor plates.

15. What will be the potential difference across this capacitor after the insulator has been removed?

- A.  $4 \mathcal{E}$       B.  $8 \mathcal{E}$       C.  $2 \mathcal{E}$       D.  $\frac{1}{2} \mathcal{E}$       E.  $\frac{1}{4} \mathcal{E}$

16. How much work would have to be done to remove the mica from between the plates?

- A.  $7 U_0$       B.  $4 U_0$       C.  $8 U_0$       D.  $3 U_0$       E.  $\frac{1}{2} U_0$

A ring with a radius  $R$  contains a positive charge  $q$  distributed uniformly along its circumference.

17. What will be the magnitude of the electric field at point P located a distance  $X$  from the center of the charged loop?

- A.  $E_x = \frac{kqx}{(x^2+R^2)^3}$       B.  $E_x = \frac{kqx}{R^3}$   
 C.  $E_x = \frac{kqx}{(x^2+R^2)^2}$       D.  $E_x = \frac{kq}{(x^2+R^2)^{3/2}}$   
 E.  $E_x = \frac{kqx}{(x^2+R^2)^{3/2}}$

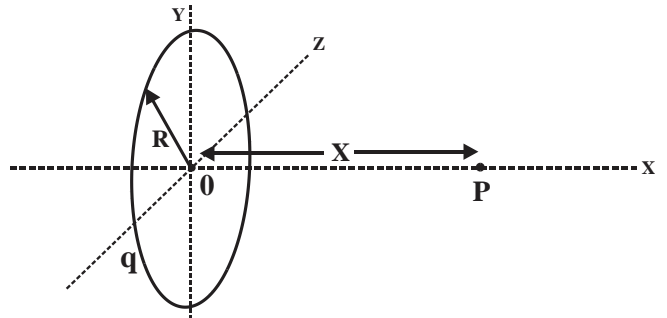

18. What will be the magnitude of the electric potential at a point P located a distance  $X$  from the center of the loop?

- A.  $V_x = \frac{kq}{(x^2+R^2)^3}$       B.  $V_x = \frac{kq}{(x^2+R^2)^2}$       C.  $V_x = \frac{kq}{\sqrt{x^2+R^2}}$       D.  $V_x = \frac{kqx}{\sqrt{x^2+R^2}}$       E.  $V_x = \frac{kqx}{R}$

An electric circuit, as shown to the right, consists of an EMF of  $\mathcal{E} = 150\text{V}$ , resistors  $R_1 = 500 \Omega$  and  $R_2 = 1000 \Omega$  and a capacitor with a capacitance of  $C = 2000 \mu\text{F}$ . At  $t = 0$  seconds, the switch  $S_1$  is closed.

19. What will be the current flowing through resistor  $R_1$  immediately after the switch has been closed?

- A. 0.050 A      B. 0.10 A      C. 0.15 A      D. 0.20 A      E. 0.30 A

20. What will be the current through Resistor  $R_1$  when measured a long time after the switch has been closed?

- A. 0.050 A      B. 0.10 A      C. 0.15 A      D. 0.20 A      E. 0.30 A

21. What will be the voltage drop measured across the capacitor  $C$  a long time after the switch has been closed?

- A. 25 V      B. 50 V      C. 100 V      D. 150 V      E. 250 V

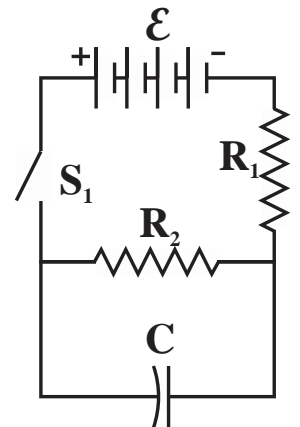

After a long time, the switch is then reopened.

22. Which of the following graphs best describes the current through  $R_2$  as a function of time?

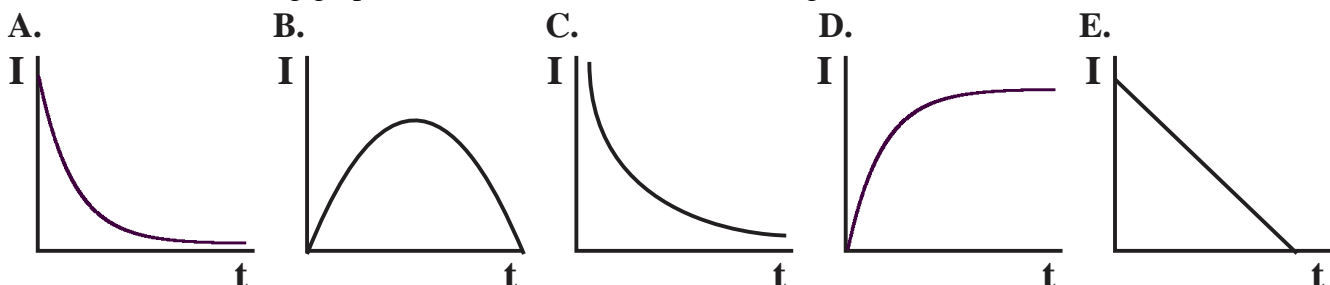

A charged insulating sphere, which has a radius of  $a$ , contains a charge  $-Q$  distributed uniformly throughout its interior. This sphere, in turn, is surrounded by a conducting spherical shell that has an inner radius of  $b$ , an outer radius of  $c$ , and which contains a total charge of  $+3Q$ .

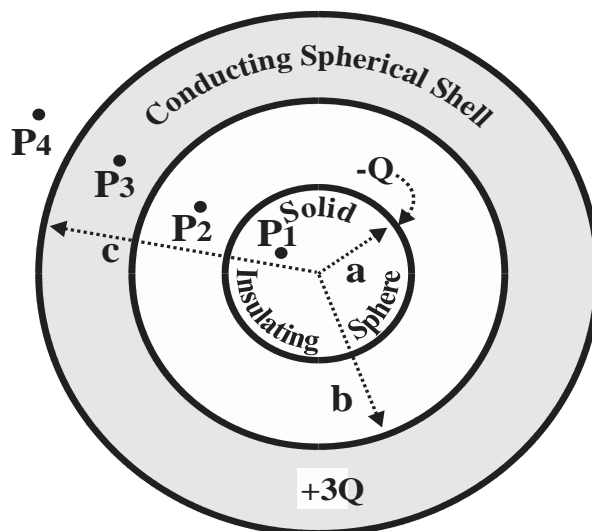

23. Which of the following expressions correctly describes the electric field within the insulated sphere?

- A.  $\frac{-3kQ}{4\pi r^2}$       B.  $\frac{-kQ}{a^3} r$       C.  $\frac{-2kQ}{4\pi r^2}$       D.  $\frac{-3kQ}{4\pi a^3} r$       E.  $\frac{-Q}{4a^3} r$

24. What will be the total charge located on the **outer** surface of the conducting, spherical shell?

- A.  $4Q$       B.  $2Q$       C.  $-3Q$       D.  $3Q$       E.  $-Q$

25. Which of the following diagrams best shows the directions of the electric fields at points  $P_4$ ,  $P_3$ , and  $P_2$ ? All full credit. A, B and C are actually correct. All full credit.

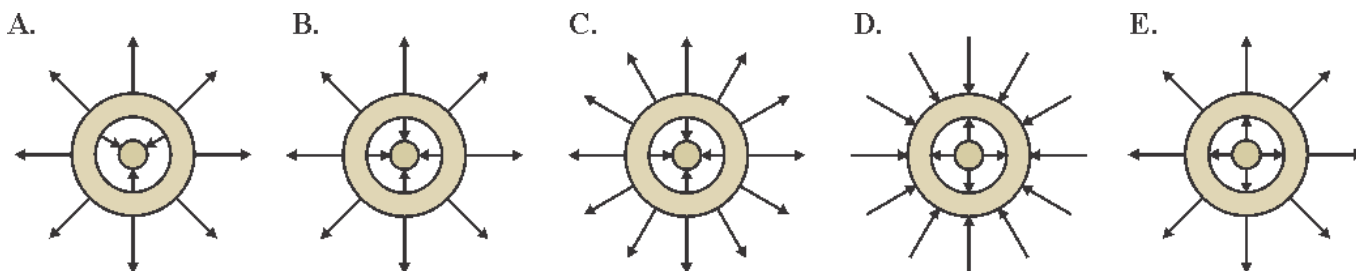



# AP Physics C Formulae 4-5-2016

## MECHANICS

$v = v_0 + at$ $x = x_0 + v_0t + \frac{1}{2}at^2$ $v^2 = v_0^2 + 2a(x - x_0)$ $\Sigma \mathbf{F} = \mathbf{F}_{net} = ma$ $\mathbf{F} = \frac{d\mathbf{p}}{dt}$ $\mathbf{J} = \int \mathbf{F} dt = \Delta \mathbf{p}$ $\mathbf{p} = m\mathbf{v}$ $F_{fric} \leq \mu N$ $W = \int \mathbf{F} \cdot d\mathbf{r}$ $K = \frac{1}{2}mv^2$ $P = \frac{dW}{dt}$ $P = \mathbf{F} \cdot \mathbf{v}$ $\Delta U_g = mgh$ $a_c = \frac{v^2}{r} = \omega^2 r$ $\boldsymbol{\tau} = \mathbf{r} \times \mathbf{F}$ $\Sigma \boldsymbol{\tau} = \boldsymbol{\tau}_{net} = I\boldsymbol{\alpha}$ $I = \int r^2 dm = \Sigma mr^2$ $\mathbf{r}_{cm} = \Sigma m\mathbf{r} / \Sigma m$ $v = r\omega$ $\mathbf{L} = \mathbf{r} \times \mathbf{p} = I\boldsymbol{\omega}$ $K = \frac{1}{2}I\omega^2$ $\omega = \omega_0 + \alpha t$ $\theta = \theta_0 + \omega_0 t + \frac{1}{2}\alpha t^2$	$a = \text{acceleration}$ $F = \text{force}$ $f = \text{frequency}$ $h = \text{height}$ $I = \text{rotational inertia}$ $J = \text{impulse}$ $K = \text{kinetic energy}$ $k = \text{spring constant}$ $\ell = \text{length}$ $L = \text{angular momentum}$ $m = \text{mass}$ $N = \text{normal force}$ $P = \text{power}$ $p = \text{momentum}$ $r = \text{radius or distance}$ $\mathbf{r} = \text{position vector}$ $T = \text{period}$ $t = \text{time}$ $U = \text{potential energy}$ $v = \text{velocity or speed}$ $W = \text{work done on a system}$ $x = \text{position}$ $\mu = \text{coefficient of friction}$ $\theta = \text{angle}$ $\tau = \text{torque}$ $\omega = \text{angular speed}$ $\alpha = \text{angular acceleration}$ $\phi = \text{phase angle}$ $\mathbf{F}_s = -k\mathbf{x}$ $U_s = \frac{1}{2}kx^2$ $x = x_{max} \cos(\omega t + \phi)$ $T = \frac{2\pi}{\omega} = \frac{1}{f}$ $T_s = 2\pi\sqrt{\frac{m}{k}}$ $T_p = 2\pi\sqrt{\frac{\ell}{g}}$ $\mathbf{F}_G = -\frac{Gm_1m_2}{r^2}\hat{\mathbf{r}}$ $U_G = -\frac{Gm_1m_2}{r}$
---	---

## ELECTRICITY AND MAGNETISM

$F = \frac{1}{4\pi\epsilon_0} \frac{q_1q_2}{r^2}$ $\mathbf{E} = \frac{\mathbf{F}}{q}$ $\oint \mathbf{E} \cdot d\mathbf{A} = \frac{Q}{\epsilon_0}$ $E = -\frac{dV}{dr}$ $V = \frac{1}{4\pi\epsilon_0} \sum_i \frac{q_i}{r_i}$ $U_E = qV = \frac{1}{4\pi\epsilon_0} \frac{q_1q_2}{r}$ $C = \frac{Q}{V}$ $C = \frac{\kappa\epsilon_0 A}{d}$ $C_p = \sum_i C_i$ $\frac{1}{C_s} = \sum_i \frac{1}{C_i}$ $I = \frac{dQ}{dt}$ $U_c = \frac{1}{2}QV = \frac{1}{2}CV^2$ $R = \frac{\rho\ell}{A}$ $\mathbf{E} = \rho\mathbf{J}$ $I = Nev_d A$ $V = IR$ $R_s = \sum_i R_i$ $\frac{1}{R_p} = \sum_i \frac{1}{R_i}$ $P = IV$ $\mathbf{F}_M = q\mathbf{v} \times \mathbf{B}$	$A = \text{area}$ $B = \text{magnetic field}$ $C = \text{capacitance}$ $d = \text{distance}$ $E = \text{electric field}$ $\mathcal{E} = \text{emf}$ $F = \text{force}$ $I = \text{current}$ $J = \text{current density}$ $L = \text{inductance}$ $\ell = \text{length}$ $n = \text{number of loops of wire per unit length}$ $N = \text{number of charge carriers per unit volume}$ $P = \text{power}$ $Q = \text{charge}$ $q = \text{point charge}$ $R = \text{resistance}$ $r = \text{distance}$ $t = \text{time}$ $U = \text{potential or stored energy}$ $V = \text{electric potential}$ $v = \text{velocity or speed}$ $\rho = \text{resistivity}$ $\phi_m = \text{magnetic flux}$ $\kappa = \text{dielectric constant}$ $\oint \mathbf{B} \cdot d\boldsymbol{\ell} = \mu_0 I$ $d\mathbf{B} = \frac{\mu_0 I d\boldsymbol{\ell} \times \mathbf{r}}{4\pi r^3}$ $\mathbf{F} = \int I d\boldsymbol{\ell} \times \mathbf{B}$ $B_s = \mu_0 nI$ $\phi_m = \int \mathbf{B} \cdot d\mathbf{A}$ $\mathcal{E} = \oint \mathbf{E} \cdot d\boldsymbol{\ell} = -\frac{d\phi_m}{dt}$ $\mathcal{E} = -L \frac{dI}{dt}$ $U_L = \frac{1}{2}LI^2$
--	--



# AP Physics C Formulae 4-5-2016

## GEOMETRY AND TRIGONOMETRY

Rectangle

$$A = bh$$

Triangle

$$A = \frac{1}{2}bh$$

Circle

$$A = \pi r^2$$

$$C = 2\pi r$$

$$s = r\theta$$

Rectangular Solid

$$V = \ell wh$$

Cylinder

$$V = \pi r^2 \ell$$

$$S = 2\pi r \ell + 2\pi r^2$$

Sphere

$$V = \frac{4}{3}\pi r^3$$

$$S = 4\pi r^2$$

Right Triangle

$$a^2 + b^2 = c^2$$

$$\sin \theta = \frac{a}{c}$$

$$\cos \theta = \frac{b}{c}$$

$$\tan \theta = \frac{a}{b}$$

$A$  = area

$C$  = circumference

$V$  = volume

$S$  = surface area

$b$  = base

$h$  = height

$\ell$  = length

$w$  = width

$r$  = radius

$s$  = arc length

$\theta$  = angle

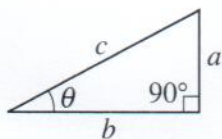
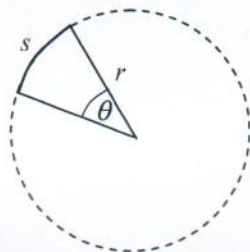

## CALCULUS

$$\frac{df}{dx} = \frac{df}{du} \frac{du}{dx}$$

$$\frac{d}{dx}(x^n) = nx^{n-1}$$

$$\frac{d}{dx}(e^{ax}) = ae^{ax}$$

$$\frac{d}{dx}(\ln ax) = \frac{1}{x}$$

$$\frac{d}{dx}[\sin(ax)] = a \cos(ax)$$

$$\frac{d}{dx}[\cos(ax)] = -a \sin(ax)$$

$$\int x^n dx = \frac{1}{n+1} x^{n+1}, n \neq -1$$

$$\int e^{ax} dx = \frac{1}{a} e^{ax}$$

$$\int \frac{dx}{x+a} = \ln|x+a|$$

$$\int \cos(ax) dx = \frac{1}{a} \sin(ax)$$

$$\int \sin(ax) dx = -\frac{1}{a} \cos(ax)$$

## VECTOR PRODUCTS

$$\vec{A} \cdot \vec{B} = AB \cos \theta$$

$$|\vec{A} \times \vec{B}| = AB \sin \theta$$

# Physics C Answer Key: Orchid Test

March 10, 2016

Record on the area record the % correct (**Corrections**)

1-E(all full credit)	6-B	11-D	16-A	21-C
2-C	7-A	12-D	17-E	22-A
3-D	8-C	13-E	18-C	23-B
4-D	9-C	14-D	19-E	24-B
5-A	10-D	15-B	20-B	25-B, (all full credit)

## Topics:

**JANUARY:** kinematics in one and two dimensions; Newton's laws including resistance forces and dynamics of circular motion; vector algebra (mostly assumed as needed); energy and its conservation including potential energy and conservative forces, momentum and its conservation including two-dimensional situations

**FEBRUARY:** angular mechanics including rotational equilibrium, rotational dynamics, rotational energy, and angular momentum; oscillatory motion including kinematics, dynamics, energy, and damping; gravitation including kinematics and dynamics of planetary motion, angular momentum, and energy as applied to gravitation

**MARCH:** electrostatics including electrostatic forces, electrostatic field, electrostatic field flux and Gauss's Law; electrostatic potential and potential energy; dc electrical circuits including multi-loop circuits and power; capacitors, dielectrics, and circuits with capacitors

**APRIL:** Magnetic Fields and Forces including the applications of the Lorenz force, the Law of Biot-Savart, Ampere's Law, magnetic field flux and Faraday's Law, Lenz's Law for electromagnetic induction; magnetic materials, applications of electromagnetic induction, and circuits with inductors.

### Testing Dates for 2016

Thursday, March 10, 2016

Thursday, April 14, 2016\*

\*All areas and schools must complete the April exam and mail in the results by April 28<sup>th</sup>, 2016.

### **New Jersey Science League**

**PO Box 65 Stewartville, NJ 08886-0065**

**Phone #:** 908-213-8923

**Fax #:** 908-213-9391

**email:** [newjsl@ptd.net](mailto:newjsl@ptd.net)

**Web address:** [entnet.com/~personal/njscil/html](http://entnet.com/~personal/njscil/html)

**PLEASE RETURN THE AREA RECORD SHEET AND ALL REGULAR TEAM MEMBER  
SCANTRONS (ALL STUDENTS PLACING 1<sup>ST</sup>, 2<sup>ND</sup>, 3<sup>RD</sup>, 4<sup>TH</sup>).**

If you return scantrons of the Alternates, then label them as **ALTERNATES.**

### **Dates for 2017 Season**

Thursday, January 12, 2017

Thursday, February 9, 2017

Thursday, March 9, 2017

Thursday, April 13, 2017

## Physics C Science League Test Orchid

April 14, 2016 (Corrections)

DIRECTIONS: Please PRINT your name, school, area, and which test you are taking on the Scantron supplied. For each statement or question, completely fill in the appropriate space on the answer sheet. Use the letter preceding the word or phrase or sketch which best completes the statement or answers the question.

1. Which combination of units can be used to express the *magnetic field*?

- |  |   |
|--|---|
| a. $\text{kg} \cdot \text{m}^2/\text{C}$ | d. $\text{kg}/(\text{C} \cdot \text{s})$                  |
| b. $\text{kg} \cdot \text{s}/\text{C}^2$ | e. $\text{kg} \cdot \text{m}/(\text{C} \cdot \text{s}^2)$ |
| c. $\text{N} \cdot \text{m}^2/\text{C}$  |   |

2. What must be the speed of the sliding bar when the current in the resistor is 0.5A? Given that  $B=1\text{T}$ ,  $R=2\Omega$  and  $w=0.5\text{m}$ ? Answer is letter A.

- a. 2m/s
- b. 4m/s
- c. 1m/s
- d. 3m/s
- e. 5m/s

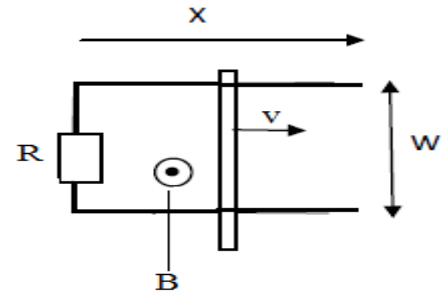

3. Which one of the following statements concerning the magnetic force on a charged particle in a magnetic field is **true**?

- a. The magnetic force is a maximum if the particle is stationary.
- b. The magnetic force is zero if the particle moves perpendicular to the field.
- c. The magnetic force is a maximum if the particle moves parallel to the field.
- d. The magnetic force acts in the direction of motion for a positively charged particle.
- e. The magnetic force depends on the component of the particle's velocity that is perpendicular to the field.

4. Two charged particles of equal mass are traveling in circular orbits in a region of uniform, **constant magnetic field** as shown. The particles are observed to move in circular paths of radii  $R_1$  and  $R_2$  with speeds  $v_1$  and  $v_2$ , respectively.

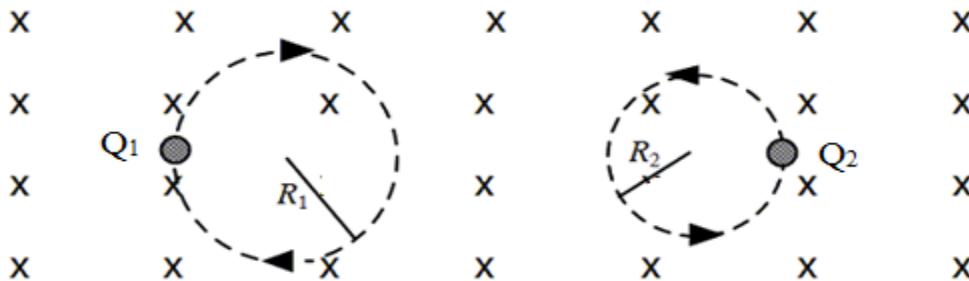

As the figure shows, the path of particle 2 has a smaller radius than that of particle 1. Which one of the following statements about this system is **false**?

- a. The particle velocities have no components parallel to the magnetic field.
- b. Neither particle gains energy from the magnetic field.
- c. Particle 1 carries a negative charge.
- d. Particle 2 carries a positive charge.
- e.  $|v_1/Q_1| < |v_2/Q_2|$

5. An electron is moving with a speed of  $3.5 \times 10^5$  m/s when it encounters a magnetic field of 0.60 T. The direction of the magnetic field makes an angle of  $60.0^\circ$  with respect to the velocity of the electron. What is the magnitude of the magnetic force on the electron?

- a.  $4.9 \times 10^{-13}$  N
- b.  $3.2 \times 10^{-13}$  N
- c.  $1.7 \times 10^{-13}$  N
- d.  $3.4 \times 10^{-14}$  N
- e.  $2.9 \times 10^{-14}$  N

6. A single circular loop of radius 1.00 m carries a current of 10.0 mA. It is placed in a uniform magnetic field of magnitude 0.500 T that is directed parallel to the plane of the loop as shown in the figure below. What is the magnitude of the torque exerted on the loop by the magnetic field?

- a. zero N · m
- b.  $1.57 \times 10^{-2}$  N·m
- c.  $3.14 \times 10^{-2}$  N·m
- d.  $6.28 \times 10^{-2}$  N·m
- e.  $9.28 \times 10^{-2}$  N·m

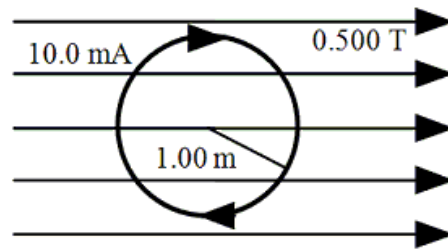

7. A long, straight, vertical segment of wire traverses a magnetic field of magnitude 2.0 T in the direction shown in the diagram below. The length of the wire that lies in the magnetic field is 0.060 m. When the switch is closed, a current of 4.0 A flows through the wire from point P to point Q.

Which one of the following statements concerning the effect of the magnetic force on the wire is **true**?

- a. The wire will be pushed to the left.
- b. The wire will be pushed to the right.
- c. The wire will have no net force acting on it.
- d. The wire will be pushed downward, into the plane of the paper.
- e. The wire will be pushed upward, out of the plane of the paper.

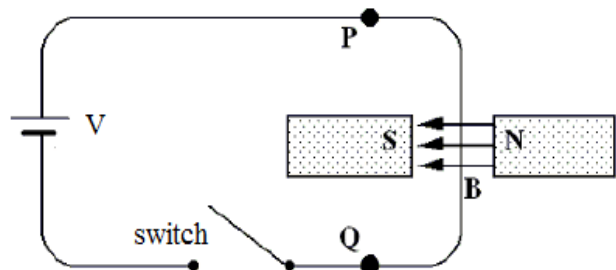

8. A long straight wire carries a 40.0 A current in the  $+x$  direction. At a particular instant, an electron moving at  $1.0 \times 10^7$  m/s in the  $+y$  direction is 0.10 m from the wire. The charge on the electron is  $-1.6 \times 10^{-19}$  C. What is the force on the electron at this instant?

- a.  $1.3 \times 10^{-16}$  N in the  $+x$  direction
- b.  $1.3 \times 10^{-16}$  N in the  $-x$  direction
- c.  $6.5 \times 10^{-10}$  N in the  $+y$  direction
- d.  $6.5 \times 10^{-10}$  N in the  $-y$  direction
- e.  $6.5 \times 10^{-16}$  N in the  $-y$  direction

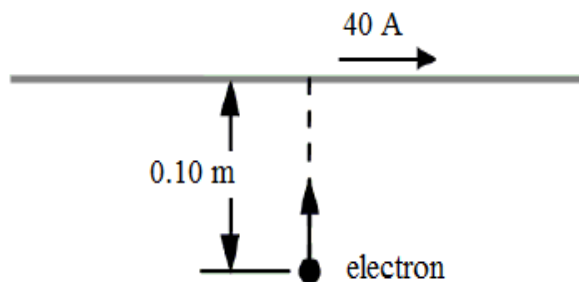

9. An proton travels through a region of space with no acceleration. Which one of the following statements is the best conclusion?

Note:  $\mathbf{E}$  represent the electric field vector and  $\mathbf{B}$  represent magnetic field vector.

- a. Both  $\mathbf{E}$  and  $\mathbf{B}$  must be zero in that region.
- b.  $\mathbf{E}$  must be zero, but  $\mathbf{B}$  might be non-zero in that region.
- c.  $\mathbf{E}$  and  $\mathbf{B}$  might both be non-zero, but they must be mutually perpendicular.
- d.  $\mathbf{B}$  must be zero, but  $\mathbf{E}$  might be non-zero in that region.
- e.  $\mathbf{E}$  and  $\mathbf{B}$  might both be non-zero, but they must point in opposite directions.

10. Consider that a sliding conductive bar closes the circuit shown below and moves to the right with a speed  $v=4$ m/s. If  $L=1.5$ m,  $R=12\Omega$  , and  $B=5$ T, then find the magnitude of the induced power and the direction of the induced current.

- a. 75W, counterclockwise
- b. 75W, clockwise
- c. 2.5W counterclockwise
- d. 2.5W clockwise
- e. 0W, there is no current flow

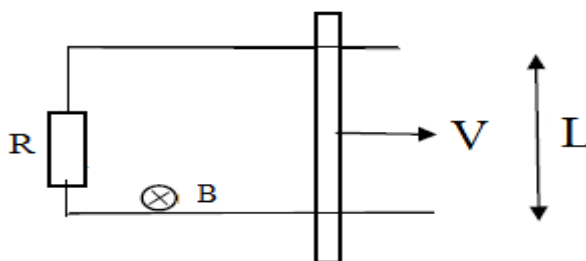

11. Use the information given in the figure below for the series RCL circuit to determine its total impedance. The switch is 60.0 Hz, 150  $\Omega$  resistor,  $1.75 \times 10^{-6}$ F, and 0.035 H

- a. 300  $\Omega$
- b. 500  $\Omega$
- c. 1500  $\Omega$
- d. 1700  $\Omega$
- e. 1900  $\Omega$

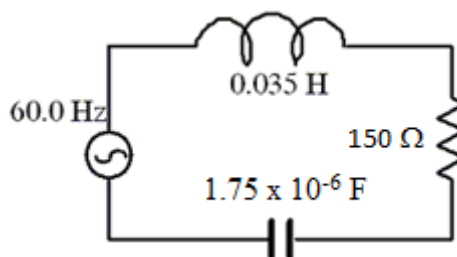

12. A mass spectrometer is used to separate two isotopes of uranium with masses  $m_1$  and  $m_2$  where  $m_2 > m_1$ . The two types of uranium atom exit an ion source S with the same charge of  $+e$  and are accelerated through a potential difference  $V$ . The charged atoms then enter a constant, uniform magnetic field  $B$  as shown. If  $r_1 = 0.5049$  m and  $r_2 = 0.5081$  m, what is the value of the ratio  $m_1/m_2$ ?

- a. 0.9984
- b. 0.9937
- c. 0.9812
- d. 0.9749
- e. 0.9874

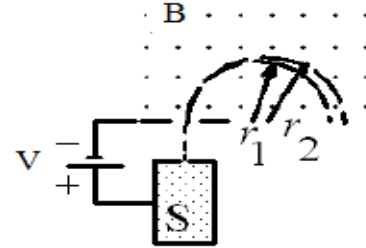

13. The value of  $\int B ds$  along a closed path in a magnetic field  $B$  is  $6.28 \times 10^{-6} \text{ T}\cdot\text{m}$ . What is the total current that passes through this closed path?

Correct answer is E

- a. 0.1A
- b. 0.5A
- c. 1A
- d. 4A
- e. 5A

14. A circular disk of radius  $a$  is rotating at a constant angular speed  $\omega$  in a uniform magnetic field,  $B$ , which is directed out of the plane of the page. Determine the induced emf between the center of the disk and the rim. Correct answer is C

- a.  $1/2 \omega Ba$
- b.  $1/2 Ba$
- c.  $1/2 \omega Ba^2$
- d.  $\omega Ba^2$
- e.  $2\pi \omega Ba^2$

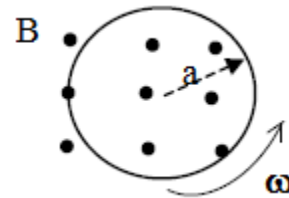

15. A conducting loop has an area of  $0.065 \text{ m}^2$  and is positioned such that a uniform magnetic field is perpendicular to the plane of the loop. When the magnitude of the magnetic field decreases to 0.30 T in 0.087 s, the average induced emf in the loop is 1.2 V. What is the **initial** value of the magnetic field?

- a. 0.42 T
- b. 0.75 T
- c. 0.87 T
- d. 1.2T
- e. 1.9T

Questions 16-17 A circuit contains a solenoid of inductance  $L$  in series with a resistor of resistance  $R$  and a battery with terminal voltage  $\mathcal{E}$ . At  $t=0$  a switch is closed and the circuit is completed.

16. When the current reaches its maximum value, how much energy is stored in the magnetic field of the solenoid?

Correct answer is D

a.  $L^2\mathcal{E}^2/(4R^2)$

d.  $L\mathcal{E}^2/(2R^2)$

b.  $L^2\mathcal{E}^2/(2R^2)$

e. 0

c.  $L\mathcal{E}^2/(4R^2)$

17. When the current reaches its maximum value, what is the total magnetic flux through the solenoid.

Correct answer is B

a.  $L\mathcal{E}$

d.  $RL/\mathcal{E}$

b.  $L\mathcal{E}/R$

e. 0

c.  $\mathcal{E}/LR$

18. Two particles move through a uniform magnetic field that is directed out of the plane of the page. The figure shows the paths taken by the two particles as they move through the field. The particles are not subject to any other forces or fields. Which one of the following statements concerning these particles is **true**?

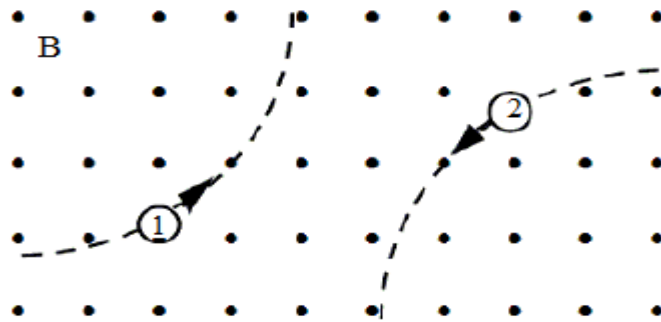

- a. The particles may both be neutral.
- b. Particle 1 is positively charged; 2 is negative.
- c. Particle 1 is positively charged; 2 is positive.
- d. Particle 1 is negatively charged; 2 is negative.
- e. Particle 1 is negatively charged; 2 is positive.

19. Which one of the following statements concerning the **energy** carried by an electromagnetic wave is true?

- a. The energy is carried only by the electric field.
- b. More energy is carried by the electric field than by the magnetic field.
- c. The energy is carried equally by the electric and magnetic fields.
- d. More energy is carried by the magnetic field than by the electric field.
- e. The energy is carried only by the magnetic field.

20. A nonconducting sphere is given a nonzero net electric charge,  $+Q$ , and then brought close to a neutral conducting sphere of the same radius.

Which of the following will be true?

- a. An electric field will be induced within the conducting sphere
- b. The conduction sphere will develop a net electric charge of  $-Q$

- c. The spheres will experience an electrostatic attraction
- d. The spheres will experience an electrostatic repulsion
- a. The spheres will experience no electrostatic interaction

21. Which of the following would increase the capacitance of the parallel plate capacitor?
- a. Using smaller plates
  - b. Replacing the dielectric material between the plates with one that has a smaller dielectric constant
  - c. Decreasing the voltage between the plates
  - d. increasing the voltage between the plates
  - e. moving the plates closer together.

22. Which one of the following statements concerning the magnetic field inside (far from the ends) a long, current-carrying solenoid is true?

- a. The magnetic field is zero.
- b. The magnetic field is non-zero and nearly uniform.
- c. The magnetic field is independent of the number of windings.
- d. The magnetic field is independent of the current in the solenoid.
- e. The magnetic field varies as  $1/r$  as measured from the solenoid axis.

23. Traveling at an initial speed of  $1.5 \times 10^6 \text{ m/s}$ , a proton enters a region of constant magnetic field,  $B$ , of magnitude 1T. If the proton's initial velocity vector makes an angle of  $30^\circ$  with the direction of  $B$ , compute the proton's speed 4 s after entering the magnetic field.

- a.  $5 \times 10^5 \text{ m/s}$
- b.  $7.5 \times 10^5 \text{ m/s}$
- c.  $1.5 \times 10^6 \text{ m/s}$
- d.  $3 \times 10^6 \text{ m/s}$
- e.  $6 \times 10^6 \text{ m/s}$

24. The figure shows a cross section of two concentric spherical metal shells of radii  $R$  and  $2R$ , respectively. Find the capacitance.

- a.  $1/(8\pi\epsilon_0 R)$
- b.  $1/(4\pi\epsilon_0 R)$
- c.  $2\pi\epsilon_0 R$
- d.  $4\pi\epsilon_0 R$
- e.  $8\pi\epsilon_0 R$

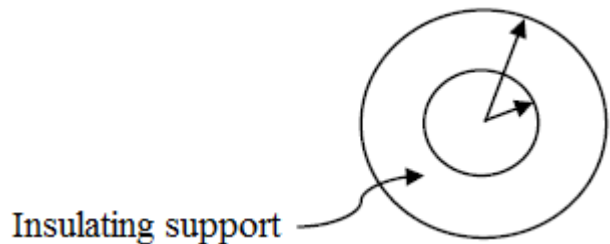

25. A battery is connected in series with a switch, a resistor of resistance  $R$ , and an inductor of inductance  $L$ . Initially, there is no current in the circuit. Once the switch is closed and the circuit is completed, how long will it take for the current to reach 99% of its maximum value?

- a.  $(\ln 0.99)RL$
- b.  $(\ln 100)RL$
- c.  $\ln(1/100)L/R$
- d.  $(L/R)(\ln 100/99)$
- e.  $(\ln 100)L/R$





# AP Physics C Formulae 4-5-2016

## MECHANICS

$v = v_0 + at$ $x = x_0 + v_0t + \frac{1}{2}at^2$ $v^2 = v_0^2 + 2a(x - x_0)$ $\Sigma \mathbf{F} = \mathbf{F}_{net} = ma$ $\mathbf{F} = \frac{d\mathbf{p}}{dt}$ $\mathbf{J} = \int \mathbf{F} dt = \Delta \mathbf{p}$ $\mathbf{p} = m\mathbf{v}$ $F_{fric} \leq \mu N$ $W = \int \mathbf{F} \cdot d\mathbf{r}$ $K = \frac{1}{2}mv^2$ $P = \frac{dW}{dt}$ $P = \mathbf{F} \cdot \mathbf{v}$ $\Delta U_g = mgh$ $a_c = \frac{v^2}{r} = \omega^2 r$ $\boldsymbol{\tau} = \mathbf{r} \times \mathbf{F}$ $\Sigma \boldsymbol{\tau} = \boldsymbol{\tau}_{net} = I\boldsymbol{\alpha}$ $I = \int r^2 dm = \Sigma mr^2$ $\mathbf{r}_{cm} = \Sigma m\mathbf{r} / \Sigma m$ $v = r\omega$ $\mathbf{L} = \mathbf{r} \times \mathbf{p} = I\boldsymbol{\omega}$ $K = \frac{1}{2}I\omega^2$ $\omega = \omega_0 + \alpha t$ $\theta = \theta_0 + \omega_0 t + \frac{1}{2}\alpha t^2$	$a = \text{acceleration}$ $F = \text{force}$ $f = \text{frequency}$ $h = \text{height}$ $I = \text{rotational inertia}$ $J = \text{impulse}$ $K = \text{kinetic energy}$ $k = \text{spring constant}$ $\ell = \text{length}$ $L = \text{angular momentum}$ $m = \text{mass}$ $N = \text{normal force}$ $P = \text{power}$ $p = \text{momentum}$ $r = \text{radius or distance}$ $\mathbf{r} = \text{position vector}$ $T = \text{period}$ $t = \text{time}$ $U = \text{potential energy}$ $v = \text{velocity or speed}$ $W = \text{work done on a system}$ $x = \text{position}$ $\mu = \text{coefficient of friction}$ $\theta = \text{angle}$ $\tau = \text{torque}$ $\omega = \text{angular speed}$ $\alpha = \text{angular acceleration}$ $\phi = \text{phase angle}$ $\mathbf{F}_s = -k\mathbf{x}$ $U_s = \frac{1}{2}kx^2$ $x = x_{max} \cos(\omega t + \phi)$ $T = \frac{2\pi}{\omega} = \frac{1}{f}$ $T_s = 2\pi\sqrt{\frac{m}{k}}$ $T_p = 2\pi\sqrt{\frac{\ell}{g}}$ $\mathbf{F}_G = -\frac{Gm_1m_2}{r^2}\hat{\mathbf{r}}$ $U_G = -\frac{Gm_1m_2}{r}$
---	---

## ELECTRICITY AND MAGNETISM

$F = \frac{1}{4\pi\epsilon_0} \frac{q_1q_2}{r^2}$ $\mathbf{E} = \frac{\mathbf{F}}{q}$ $\oint \mathbf{E} \cdot d\mathbf{A} = \frac{Q}{\epsilon_0}$ $E = -\frac{dV}{dr}$ $V = \frac{1}{4\pi\epsilon_0} \sum_i \frac{q_i}{r_i}$ $U_E = qV = \frac{1}{4\pi\epsilon_0} \frac{q_1q_2}{r}$ $C = \frac{Q}{V}$ $C = \frac{\kappa\epsilon_0 A}{d}$ $C_p = \sum_i C_i$ $\frac{1}{C_s} = \sum_i \frac{1}{C_i}$ $I = \frac{dQ}{dt}$ $U_c = \frac{1}{2}QV = \frac{1}{2}CV^2$ $R = \frac{\rho\ell}{A}$ $\mathbf{E} = \rho\mathbf{J}$ $I = Nev_d A$ $V = IR$ $R_s = \sum_i R_i$ $\frac{1}{R_p} = \sum_i \frac{1}{R_i}$ $P = IV$ $\mathbf{F}_M = q\mathbf{v} \times \mathbf{B}$	$A = \text{area}$ $B = \text{magnetic field}$ $C = \text{capacitance}$ $d = \text{distance}$ $E = \text{electric field}$ $\mathcal{E} = \text{emf}$ $F = \text{force}$ $I = \text{current}$ $J = \text{current density}$ $L = \text{inductance}$ $\ell = \text{length}$ $n = \text{number of loops of wire per unit length}$ $N = \text{number of charge carriers per unit volume}$ $P = \text{power}$ $Q = \text{charge}$ $q = \text{point charge}$ $R = \text{resistance}$ $r = \text{distance}$ $t = \text{time}$ $U = \text{potential or stored energy}$ $V = \text{electric potential}$ $v = \text{velocity or speed}$ $\rho = \text{resistivity}$ $\phi_m = \text{magnetic flux}$ $\kappa = \text{dielectric constant}$ $\oint \mathbf{B} \cdot d\boldsymbol{\ell} = \mu_0 I$ $d\mathbf{B} = \frac{\mu_0 I d\boldsymbol{\ell} \times \mathbf{r}}{4\pi r^3}$ $\mathbf{F} = \int I d\boldsymbol{\ell} \times \mathbf{B}$ $B_s = \mu_0 nI$ $\phi_m = \int \mathbf{B} \cdot d\mathbf{A}$ $\mathcal{E} = \oint \mathbf{E} \cdot d\boldsymbol{\ell} = -\frac{d\phi_m}{dt}$ $\mathcal{E} = -L \frac{dI}{dt}$ $U_L = \frac{1}{2}LI^2$
--	--

# AP Physics C Formulae 4-5-2016

## GEOMETRY AND TRIGONOMETRY

Rectangle

$$A = bh$$

Triangle

$$A = \frac{1}{2}bh$$

Circle

$$A = \pi r^2$$

$$C = 2\pi r$$

$$s = r\theta$$

Rectangular Solid

$$V = \ell wh$$

Cylinder

$$V = \pi r^2 \ell$$

$$S = 2\pi r \ell + 2\pi r^2$$

Sphere

$$V = \frac{4}{3}\pi r^3$$

$$S = 4\pi r^2$$

Right Triangle

$$a^2 + b^2 = c^2$$

$$\sin \theta = \frac{a}{c}$$

$$\cos \theta = \frac{b}{c}$$

$$\tan \theta = \frac{a}{b}$$

$A$  = area

$C$  = circumference

$V$  = volume

$S$  = surface area

$b$  = base

$h$  = height

$\ell$  = length

$w$  = width

$r$  = radius

$s$  = arc length

$\theta$  = angle

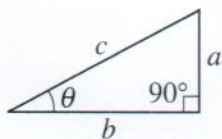
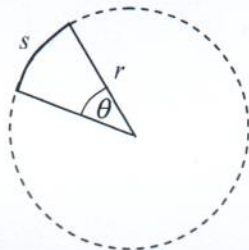

## CALCULUS

$$\frac{df}{dx} = \frac{df}{du} \frac{du}{dx}$$

$$\frac{d}{dx}(x^n) = nx^{n-1}$$

$$\frac{d}{dx}(e^{ax}) = ae^{ax}$$

$$\frac{d}{dx}(\ln ax) = \frac{1}{x}$$

$$\frac{d}{dx}[\sin(ax)] = a \cos(ax)$$

$$\frac{d}{dx}[\cos(ax)] = -a \sin(ax)$$

$$\int x^n dx = \frac{1}{n+1} x^{n+1}, n \neq -1$$

$$\int e^{ax} dx = \frac{1}{a} e^{ax}$$

$$\int \frac{dx}{x+a} = \ln|x+a|$$

$$\int \cos(ax) dx = \frac{1}{a} \sin(ax)$$

$$\int \sin(ax) dx = -\frac{1}{a} \cos(ax)$$

## VECTOR PRODUCTS

$$\vec{A} \cdot \vec{B} = AB \cos \theta$$

$$|\vec{A} \times \vec{B}| = AB \sin \theta$$

# Physics C Answer Key: Orchid Test

April 14, 2016

Solutions (Corrections)

1-D	6-B	11-C	16-A(D not A)	21-E
2-E (A not E)	7-D	12-E	17-D (B not D)	22-B
3-E	8-A	13-B (E not B)	18-D	23-C
4-E	9-C	14-E(C not E)	19-C	24-E
5-E	10-A	15-E	20-C	25-E

## Topics:

**JANUARY:** kinematics in one and two dimensions; Newton's laws including resistance forces and dynamics of circular motion; vector algebra (mostly assumed as needed); energy and its conservation including potential energy and conservative forces, momentum and its conservation including two-dimensional situations

**FEBRUARY:** angular mechanics including rotational equilibrium, rotational dynamics, rotational energy, and angular momentum; oscillatory motion including kinematics, dynamics, energy, and damping; gravitation including kinematics and dynamics of planetary motion, angular momentum, and energy as applied to gravitation

**MARCH:** electrostatics including electrostatic forces, electrostatic field, electrostatic field flux and Gauss's Law; electrostatic potential and potential energy; dc electrical circuits including multi-loop circuits and power; capacitors, dielectrics, and circuits with capacitors

**APRIL:** Magnetic Fields and Forces including the applications of the Lorenz force, the Law of Biot-Savart, Ampere's Law, magnetic field flux and Faraday's Law, Lenz's Law for electromagnetic induction; magnetic materials, applications of electromagnetic induction, and circuits with inductors.

## Testing Dates for 2016

Thursday, April 14, 2016\*

\*All areas and schools must complete the April exam and mail in the results by April 28<sup>th</sup>, 2016.

New Jersey Science League

PO Box 65 Stewartville, NJ 08886-0065

Phone #: 908-213-8923 Fax #: 908-213-9391 email: [newjssl@ptd.net](mailto:newjssl@ptd.net)

Web address: [entnet.com/~personal/njscil/html](http://entnet.com/~personal/njscil/html)

**PLEASE RETURN THE AREA RECORD SHEET AND ALL REGULAR TEAM MEMBER SCANTRONS**

**(ALL STUDENTS PLACING 1<sup>ST</sup>, 2<sup>ND</sup>, 3<sup>RD</sup>, 4<sup>TH</sup>).**

If you return scantrons of the Alternates, then label them as ALTERNATES.

**Dates for 2017 Season**

Thursday, January 12, 2017

Thursday, February 9, 2017

Thursday, March 9, 2017

Thursday, April 13, 2017